

GreenSeal Acrylic / SPF Roof Restoration System
TECHNICAL SPECIFICATION

PART 1 GENERAL REQUIREMENTS

1.01 SCOPE

- A. This guide specification covers the installation of the Sprayed Polyurethane Roofing System (SPRS) which consists of a seamless sprayed-in-place polyurethane foam insulation covered with a silicone coating for use as an insulated roofing system for both new and retrofit (re-roofing) construction.
- B. The successful application of an SPRS is dependent upon the experience, integrity, ability, technology, and common sense of the designer and applicator/contractor. This guide specification is intended as a starting point for the development of more complete specifications for SPRS.
- C. The manufacturer's application instruction for each product utilized is to be considered part of these specifications and should be followed at all times.

1.02 QUALITY ASSURANCE

- A. Supplier Qualifications: The GreenSeal System, as supplied by UltraTite Solutions, LLC (UltraTite), is approved for use on the project.
- B. Applicator Qualifications: The applicator shall be approved by UltraTite to apply the system. The manufacturer's written verification of applicator approval is required.
- C. In the absence of a general contractor, the roofing contractor shall be the prime contractor. All subcontractors shall be identified and approved at the time the proposal is submitted. The contractor shall carry a valid state roofing license.
- D. Field Quality Control: Upon completion of the GreenSeal System installation, an inspection by UltraTite or UltraTite's designated third-party inspection firm may be required. Consult with UltraTite for details and warranty requirements.

1.03 SUBMITTALS

- A. The bidders shall submit verification that they are an approved UltraTite contractor.
- B. A copy of the manufacturer's technical data bulletins for specified foam and coating materials shall be submitted.

1.04 APPROVED SUBSTRATES

- A. Approved substrates include the following:
 - Built-up Roofing (Gravel Surfaced or Cap Sheet)
 - Metal decks
 - Structural Concrete
 - Structural Plywood

1.05 PRODUCTS, DELIVERY, AND STORAGE

GreenSeal: acrylic

- A. Products shall be delivered in the manufacturer's original, unopened containers, clearly labeled with the manufacturer's name, product identification, safety information, and lot numbers.
- B. Containers shall be stored out of the weather and out of direct sunlight at temperatures specified by the manufacturer.
- C. Protect all products from freezing and other damage during transit, handling, storage, and installation.

1.06 PROJECT CONDITIONS

- A. Weather conditions must be within those listed on the manufacturer's technical data bulletins. If weather conditions change during the application and the stated conditions are not met, the application must be stopped until the specified conditions are met. No application may proceed during inclement weather.
- B. All material must be installed in strict accordance with all published safety, weather, or applicable regulations of the manufacturer and/or federal agencies that have jurisdiction.

1.07 DETAIL WORK

- A. Refer to UltraTite Detail Drawings for preparation and finishing of drains, vents, ducts, flashings, parapet walls, etc. The contractor should outline this work before work commences and the work shall be performed by observing good trade practices. Any details not shown in the drawings need to be approved by UltraTite before application.

1.08 SCHEDULING

- A. All other trades such as structural, mechanical, and electrical should have completed their work before the installation of the SPRS.

1.09 WARRANTY

- A. Warranty Submittals to Spray Polyurethane Foam and Roof Coating Manufacturer:
 - 1. Contact an UltraTite representative for a complete list of required documents and procedures before purchasing material. Warranties submitted without required documents and procedures completed may result in delay or rejection of warranty request.
- B. The polyurethane and acrylic elastomeric system is available in 10, 15, and 20-year Limited Labor Warranty:
 - 1. Installing Subcontractor must warranty the system and installation for two (2) years.
 - 2. Spray Polyurethane Foam and Roof Coating Manufacturer must warranty the system and installation; provide material and labor costs for repair in the event of an leak as a result of faulty material or faulty workmanship for a period of 10, 15, or 20 years from the date of substantial completion.
 - a. Warranty terms are based on cured roof coating thickness.
 - b. Refer to Part 3 Execution.

GreenSeal: acrylic

- C. Warranty terms shall begin upon “essential completion of SPRS construction” or completion of final inspection/punch list items (if any) not to exceed 45 days from the date that UltraTite is notified by the contractor with a written request for warranty.

1.10 INSPECTION

- A. A representative of the material manufacturer shall inspect the roof after completion to assure that all work has been completed in conformance with the specifications and accepted industry practice. All material thickness shall be verified.

PART 2 PRODUCTS

2.01 PRIMER AND INTENDED APPLICATION SUBSTRATE

- A. Depending on the substrate that the GreenSeal system is being applied to, it may require a primer to perform properly. Consult the UltraTite Representative to determine the primer needed.
- B. New galvanized steel and existing flashings:
 - 1. Galvanized metal and other non-ferrous metals: Use GreenPrime Metal primer.

2.02 BASE SHEET AND FASTENERS

- A. A base sheet, if required, shall be repaired with like material to maintain the current fire rating classification.
- B. Nailable decks; The fasteners shall be the 1-inch, square head, ring-shank nails as manufactured by Simplex or equal with sufficient length to penetrate sheathing or embed a minimum of 1-inch into the sheathing.
- C. Mechanical fasteners and plates; screws shall be No. 12, coated, self-taping screws of sufficient length to penetrate the existing BUR and insulation with 1-inch penetration (minimum) into the substrate. The plates shall be 2-inch, coated plates. The screws and plates shall be manufactured by Olympic, DeckFast, or equal.

2.03 RECOVER BOARD/FIRE PROTECTION BOARD

- A. A recover board or fire protection board between a wood deck using diagonal sheathing or insulation board, if required, shall be Georgia-Pacific Corporation ¼-inch Dens-Deck or equal 4' x 8' sheets. Recover board may be installed parallel or perpendicular to the sheathing, stagger all joints.

2.04 SPRAY POLYURETHANE FOAM INSULATION

- A. Spray polyurethane insulation shall be a two-component polyurethane insulation system formulated for use through airless equipment. The product shall be GreenSeal2.5-3.0 series as manufactured by UltraTite, Houston, TX. The product shall exhibit the following typical physical properties:

Density (sprayed in place): 2.5 – 3.0 pcf
Compressive strength: >40 psi (nominal)
Tensile strength: 90 psi
Shear strength: 45 psi

Closed cell content: 90% min.

K factor (aged): 0.156

Flame spread UL-723 (ASTM E-84): <75*

Roof Deck Classification UL 790 (ASTM E-108): Maintenance and Repair Class A
FMRC 4470

***This numerical flame spread rating is not intended to reflect hazards presented by this or any other material under actual fire conditions.**

2.05 FLUID APPLIED ACRYLIC COATINGS

- A. The coating shall be the GreenCoat elastomeric acrylic coating, manufactured by UltraTite.
- B. Physical Properties of Cured Coating System:

PROPERTY	ASTM METHOD	RESULTS	GreenCoat
Tensile Strength, psi (Max @ 73°F)	D6694/ D-2370	Minimum 150	283
% Elongation @ Break (73°F)	D6694/ D-2370	Minimum 100	253%
Volume Solids %	D6694/ D-2697	> 57	55.0
Weight Solids %	D6694/ D-1644	Report Value	65.0

2.06 CAULKING OR SEALANTS

- A. The caulking material shall be GreenCoat FG. Caulking of fabricated metal components or lapping metal joints (except equipment pan seams) is required.

2.07 GRANULES

- A. Granules shall be Dust Free White granules and shall be broadcast into the final coating application while it is still wet (Only if specified for the project).

2.08 EQUIPMENT

- A. Equipment for spraying foam shall be manufactured specifically for the application of polyurethane foam. The equipment shall be capable of maintaining a 1:1 volume ratio and have primary and hose heaters (350 feet of material hose maximum allowable to meet mix pressure requirements, GX-7 gun or equivalent is recommended)
- B. Coating equipment shall be an airless type as recommended by UltraTite.

PART 3 EXECUTION

3.01 GENERAL

- A. In the absence of a general contractor, the roofing contractor is the prime contractor and shall be responsible for additional roof-related work which may include but not be limited to the following:
 1. Verification of all measurements relative to this project.

2. Raising, repairing, and modifying existing air conditioning systems for the installation of curbs, metal pans, and ductwork.

3.02 ROOF RELATED CARPENTRY WORK, STRUCTURAL CERTIFICATION, AND SLOPE

A. Roofing contractor shall ensure the following:

1. Roof-related metal work: All metal work to receive insulation directly shall be cleaned and free from oil, dirt, and oxidation and shall be primed.
2. All utility rigid conduits must be raised sufficiently for the unobstructed application of roofing insulation materials underneath. The conduit may be raised permanently or temporarily and reset upon new wood sleepers on top of the new SPRS.
3. Overflow drains or scuppers shall be added to the existing drain system if nonexistent or not in accordance with the local building code. All new drains/scuppers shall comply with the local building code.
4. All rooftop equipment shall be verified to be in proper working condition after the re-roofing work or before the next facility business day if the roof work is not yet complete.
5. Before roof construction starts, all drain bowls/sumps and associated plumbing shall be water tested to insure that they are watertight and clear to the discharge level.
6. A roof slope of $\frac{1}{4}$ inch in 12 inches (approximately 2%) is recommended but not required.

3.03 SURFACE CONDITION

- A. The contractor shall be responsible for determining whether the roof deck complies with applicable building codes.
- B. The owner shall ensure that rooftop equipment does not discharge liquids onto the roof. All blowers shall exhaust into a container or the atmosphere and not onto the roof surface.
- C. The surface shall be free from solvent, grease, dust, sediment, dirt, and sticky mastic. All extraneous equipment and equipment supports shall be removed from the roof deck. The contractor shall inspect areas of the roof that have been extensively patched, exhibit weak decking, or saturated roofing material. Suspect areas shall be defined by "bracket core" sampling to determine the extent of the condition. Defective roofing materials shall be torn off and the substrate inspected for water damage. When defective decking (water damaged) is observed, and when authorized by the owner, remove and replace it with new materials which comply with local building codes. The cost to replace defective decking shall be shown on the roofing bid as a separate item and priced on a per-square-foot basis.

3.04 SURFACE PREPARATION (see attached Construction Details)

- A. Existing roofing materials shall be securely fastened using appropriate fasteners and plates to meet local wind uplift requirements (at a minimum of a two-foot grid pattern).
 1. TPO, PVC, and EPDM:
 - Must be relief cut at parapets and penetrations and fastened to decking using appropriate fasteners and plates.

- Adhesion test must be performed to determine which primer is needed.
 - B. All blisters in the built-up roofing (BUR) less than 6 inches in diameter shall be slit and fastened to the roof deck using appropriate fasteners and plates. All blisters larger than 6 inches shall be cut and removed from the deck.
 - C. Loose gravel shall be removed from all roof surfaces with a power vacuum. Power broom all vacuumed surfaces and vacuum again.
 - D. Existing edge metal shall be removed and replaced with foam stop edge metal.
 - E. All new metal flashing and existing galvanized steel surfaces shall be primed with ⅓ to ½ gallons per 100 square feet (5-8 wet mils / 3-4 dry mils) of GreenPrime Metal wash primer.
 - F. Consult your UltraTite Representative about specific primers for various surfaces.
 - G. Masking and Clean up
 - 1. All surfaces not to receive foam, such as windows, walls, air conditioners, and other roof-mounted equipment shall be carefully masked with tape and paper to avoid overspray of these surfaces with foam or coating. All coating is to be terminated in clean straight lines.
- NOTES:** When masking A/C equipment, all coverage of the air intakes shall be removed at the end of each work shift. No foam shall be allowed to accumulate on fan blades or cooling fins.
- H. Perimeter Coping Metal:
 - 1. Option 1: If coping is to remain, lap joints must be cleaned of all mastic and caulk. Coat over the dried repair. After foaming parapet walls, install a “Z” counterflashing with mechanical fasteners.
 - 2. Option 2: Remove coping. Install foam stop edge metal over parapet using appropriate fasteners 6” O.C. Foam parapet and new flashing per detail drawing.
- I. HVAC and Roof-Mounted Equipment
 - 1. **Field Assembled HVAC Curbs:**
 - a. Fully enclosed (boxed) platforms constructed from 2 x 8 (minimum) lumber with a 1/2-inch CDX plywood top shall be fabricated. The finished grade of the top of the platform shall be 8 inches (minimum) above the new roof level. A layer of single-ply roofing shall be set over the plywood top of the platform and turned down at the edge one inch. A new 24 ga. galvanized, seamless sheet metal cover shall be installed over the platform. Where large platform covers are required, all seams shall be soldered or constructed with a 1 ½ inches minimum standing seam. Caulking of the seams shall not be acceptable. The new metal cover shall be 2 inches larger than the wood curb on all sides with a 2-inch X 60° turn down and ¼-inch hem.
 - b. Before setting the new platform into place, a minimum of 4 inches of spray polyurethane foam insulation shall be applied to the underside of the platform to provide insulation, structural strength, and sound deadening. It may be necessary to foam the vertical sides of the platform before setting it into place if clearance on all four sides is not sufficient for proper foaming. Do not foam the sheet metal cover into the roof.

2. Pre-Engineered/Manufactured Curbs:

- a. New galvanized steel manufactured curbs shall be graded and installed by a licensed and certified HVAC contractor to accommodate downdraft or side discharge HVAC units. The finished grade of the top of the manufactured curb shall be 8 inches (minimum) above the new roof level. It is important that if the new curb is supplied with a nailer under the mounting flange that it be removed before sealing the curb into the roof with spray polyurethane foam and a protective coating. Steel curbs must be primed.

3. Ductwork:

- a. **Option 1:** All ductwork shall receive one inch of foam. NOTE: The duct walls at the roof penetration shall receive 1 inch of foam on all four sides with a smooth flashing transition to both the roof and the A/C platform sides (This may require either disassembly of the ductwork or moving the A/C unit prior to foaming.) Do not apply foam to the canvas connector.
 - b. **Option 2:** HVAC ducts shall be cleaned and primed before the application of GreenCoat elastomeric acrylic coating. NOTE: The duct walls at the roof penetration shall receive 1 inch of foam on all four sides with a smooth flashing transition to both the roof and the A/C platform sides (This may require either disassembly of the ductwork or moving the A/C unit prior to foaming.) Do not apply foam to the canvas connector.
4. If line voltage, low voltage, gas line, and condensate connections are new and only stubbed out, they must be a minimum of 12 inches above the finished grade of the roof and supported at the deck. NOTE: ALL ELECTRICAL CONNECTIONS AND GAS CONNECTIONS MUST BE DISCONNECTED PRIOR TO RAISING THE UNIT AND RECONNECTED AND TESTED AFTER THE UNIT IS RESET.
 5. All conduit and gas lines must be raised off the roof. After the roof has been foamed, the conduit can be reset on 2 x 4's set on top of the foam. The old conduit supports shall not be reused.

J. Internal Drains

1. All internal roof drains shall be flushed with water to ensure that the drains are clear to the discharge level before starting the roofing work.
2. Tear off all existing roofing at the dropped sump bowl. Remove the clamping ring from the drain bowl. Remove all broken bolts from clamping rings, re-drill, and tap holes as necessary for replacement with new bolts. Remove all BUR materials from the drain bowl flange and for a distance of 6 inches. Fasten the edge of the remaining BUR membrane materials to the roof deck with appropriate fasteners. Apply a bead of siliconized urethane caulking to the drain bowl clamping ring contact areas and refasten the clamping ring with new bolts. Remove excess caulking from the inside of the drain bowl and clamping ring. Mask the inside of the drain and spray a "water block" from the deck to the top of the clamping ring. Grind excess insulation flush with the top of the clamping ring. The acrylic coating shall be applied and "backrolled" in a "picture frame" fashion to achieve double the specified thickness of coating around the water entry area. Flush drains (a second time) with water to ensure that the drains are clear to the discharge level after all roofing work is completed. The strainers shall be locked over the drain opening (use existing or new locking rings or install new hardware and fasteners as necessary). All internal drains shall be fitted with appropriate strainers or leaf catchers.
3. If new strainers or catchers are required (or missing strainers or catchers need to be

replaced) they shall be metal. Plastic strainers and leaf catchers shall not be used.

- K. All A/C condensate lines shall be replaced and repaired as necessary and run to a drain or off the roof. Condensate shall not be discharged into soil pipes or other vents.
- L. Low areas over 100 square feet in size and greater than ½-inch deep shall be filled with foam to match the surrounding grade before the specified thickness of foam shall be applied.
- M. All soil pipes and other roof vents shall be masked and remain fully open after foaming.
- N. All “T” tops and other roof vents shall be raised as necessary to remain 2 inches above the new foam line. Two-way roof vents shall be eliminated.
- O. All scuppers shall be opened to comply with local codes regarding the size of the water entry opening. NOTE: Ensure that all existing scuppers are open and have not been covered with other roofing materials. Remove all BUR materials from the entire scupper and flange. Clean retained metal components and prime. Rusted metal shall be replaced to match the existing metal or better. Scuppers shall be resealed and flashed with foam.
- P. All antennae shall be attached to curbs or antenna mounts and guy wires shall not be secured through the roof.
- Q. Skylights: All skylights shall have appropriate “Fall-Through” protection. The owner may elect to replace the existing skylights with new units or repair them with UltraTite GreenCoat Glaze.
- R. Conduit and Piping:
 - 1. All small conduit and gas lines 1.5 inches and under must be raised off the roof. After the roof has been foamed, the conduit shall be reset on new redwood or treated 2 x 4’s set on top of the foam. The wood blocks shall be caulked to strips of EverTread walk pad, Yellow Spaghetti, or granule walk pads which are caulked to the top coated foam roof. The old conduit supports shall not be reused.
 - 2. Large conduit and piping 1.75 inches and larger shall have new redwood or treated blocks with 24 ga. galvanized sheet metal boxes fabricated with a minimum 6-inch flange on the roof with all joints soldered. These boxes with wood blocks shall be nailed over the existing roof membrane, primed, and foamed into place. Piping shall be set onto the blocks and covers, and conduit attached with clamps. Note: Conduit and piping which move during use such that the roof system may be damaged shall be set upon appropriate roller saddle supports or other vibration-isolating devices.

3.05 SPECIFIC SITE CONDITIONS

- A. N.A.

3.06 APPLICATION OF SPRAY POLYURETHANE INSULATION

- A. Environmental conditions
 - 1. Wind velocity shall not exceed 12 miles per hour.
 - 2. Application of spray polyurethane foam shall not proceed if the ambient temperature is less than 50 degrees Fahrenheit or if the substrate temperature is less than 60 degrees Fahrenheit.

GreenSeal: acrylic

- B. Spray polyurethane foam is not to be applied over moist substrates or when rain or inclement weather is imminent.
- C. The field of the spray polyurethane foam shall be applied in minimum ½-inch lifts to a thickness of 1 ½ inches (or as otherwise specified). Spray polyurethane foam may be gradually tapered to edge metal (1-inch rise metal), roof drains, and scuppers from a distance of up to 3 feet from an edge or drain outlet. Spray polyurethane foam may be applied to a greater thickness than ½-inch per lift if all other requirements and conditions are met. Low areas over 100 sq. ft. in size and greater than ½-inch deep shall be filled with foam to match the surrounding grade and before the specified thickness of foam shall be applied. All parapet walls shall receive a minimum of 1 inch of foam and the specified protective coating.
- D. Note: Freshly sprayed foam shall be allowed to set for 15 minutes before being walked upon.
- E. In one day, only as many areas that can be brought to final thickness should be attempted. Phasing of the foam is strictly forbidden. (Phasing is foam application on one day and coming back the next day or thereafter and applying another layer of foam. This procedure may lead to the development of blisters over time). If additional foam must be added after the 24-hour period, the existing foam should be primed on the first day, and new foam applied on the second day must be applied at a minimum of ½ inch of foam in a single pass.
- F. The foam shall be free from bumps, pinholes, and ridges. The surface shall exhibit a smooth or “orange peel” surface texture. “Popcorn” or “tree bark” surfaces shall be deemed unacceptable.
- G. At the internal drain openings, the foam shall be ground to a smooth slope for ease of water entry. New metal screens shall be provided if the original screens are broken or missing.
- H. The foam thickness shall be checked with a depth gauge every 500 square feet prior to coating application.
- I. If “slip-sheets” are needed to waterproof under piping or other obstructions, the following method shall be used:
 - 1. The specified foam thickness shall be applied to a ¼-inch Dens-Deck and positioned under the obstruction. Full edge attachment shall be accomplished using screws and 2-inch plates, 9 inches on center with screw length sufficient to penetrate the roof deck (NOTE: Leave a 4-inch gap between the end of the sheets, do not “butt-joint.” Foam a “tie-in” in the gap and trim the excess foam). If the roof deck is concrete, then “Tub-Loc”, “Zonotite”, or “Rawl Spike” fasteners shall be used. Foam shall be applied to the edges of the slip sheet and adjoining roof area and the “tie-in” ground smooth if the profile is irregular.

3.07 APPLICATION OF FLUID APPLIED PROTECTIVE COATING

- A. General
 - 1. Sprayed polyurethane foam must be protected from ultraviolet light to avoid degradation of the polymer. Materials shall be applied according to the application chart:

LABOR AND MATERIAL WARRANTY	APPROXIMATE COVERAGE RATE
5 Years	2 Gallons/sq. (32 wmt / 16 dmt)

GreenSeal: acrylic

10 Years	3 Gallons/sq. (48 wmt / 24 dmt)
15 Years	4 Gallons/sq. (64 wmt / 32 dmt)
20 Years	5.5 Gallons/sq. (80 wmt / 40 dmt)

2. acrylic coating shall be applied in a picture frame fashion and back-rolled at the roof perimeter and tops of parapet walls. The coating shall be applied to 1.5 X the specified thickness and finished with a "HEAVY APPLICATION" of roofing granules (if specified). This procedure shall ensure proper sealing of these critical areas.
3. Other areas where the foam has been ground shall also be back-rolled and coated to 1.5 X the specified coating thickness.

B. Spray Applications

1. The coating is to be applied to the surface of the roofing foam in uniform passes. The base coats and topcoat shall be of contrasting colors to assure uniformity of coverage. The topcoat color shall be white where required.
2. The specified thickness of the coating shall be verified using an optical comparator.

C. Granules (if specified)

1. A total of 40 to 50 lbs. per 100 square feet of dust-free granules shall be broadcast into the final topcoat while it is still wet. Complete coverage with granules to the point of "refusal" shall be required. Areas without granule cover (bare spots or "shiners") shall be re-coated and granulated to provide complete coverage.
2. Rooftop landings, the areas surrounding equipment installation, the decks in equipment wells, and walkways between equipment shall receive an additional coating application and granule surfacing application.
3. Remove all loose granules after the roof coating has cured to prevent them from washing into gutters or onto the ground.

D. Walkways (Option)

1. Areas approximately 4 feet wide around HVAC equipment installations and at the roof access hatchway shall receive the following treatment: After the initial granule finish has completely cured, all loose granules shall be removed and an additional 2.0 gallons per 100 square feet (32 wet mils / 28 dry mils) of protective top coating shall be applied, with 40 to 50 lbs. per 100 square feet of ceramic granules embedded into the wet coating. Walkway granules shall be a contrasting color (White, Gray, or Tan) to those used to finish the roof field.

3.08 CLEANING

- A. Promptly as the work proceeds, and upon completion, all rubbish and surplus materials resulting from the foregoing work shall be cleaned up and removed from the job site.
- B. Soiled surfaces, spatters, and damage caused by work of this section shall be cleaned.

GreenSeal: acrylic

- C. The area shall be checked to ensure cleanliness and debris, equipment, and excess material shall be removed from the site.

3.09. MATERIAL

- A. The following materials are available from UltraTite:
 - 1. GreenCoat – acrylic high-performance roof coating
 - 2. GreenCoat Flashing Grade - Flashing Grade acrylic
 - 3. GreenSeal 2.5/2.8/3.0 Two Component HFO Blown Spray Urethane Foam
 - 4. GreenLevel – 2 Component Roof Leveling Compound

3.010. DETAIL DRAWINGS

DETAIL 12, BUILDING EXPANSION JOINT

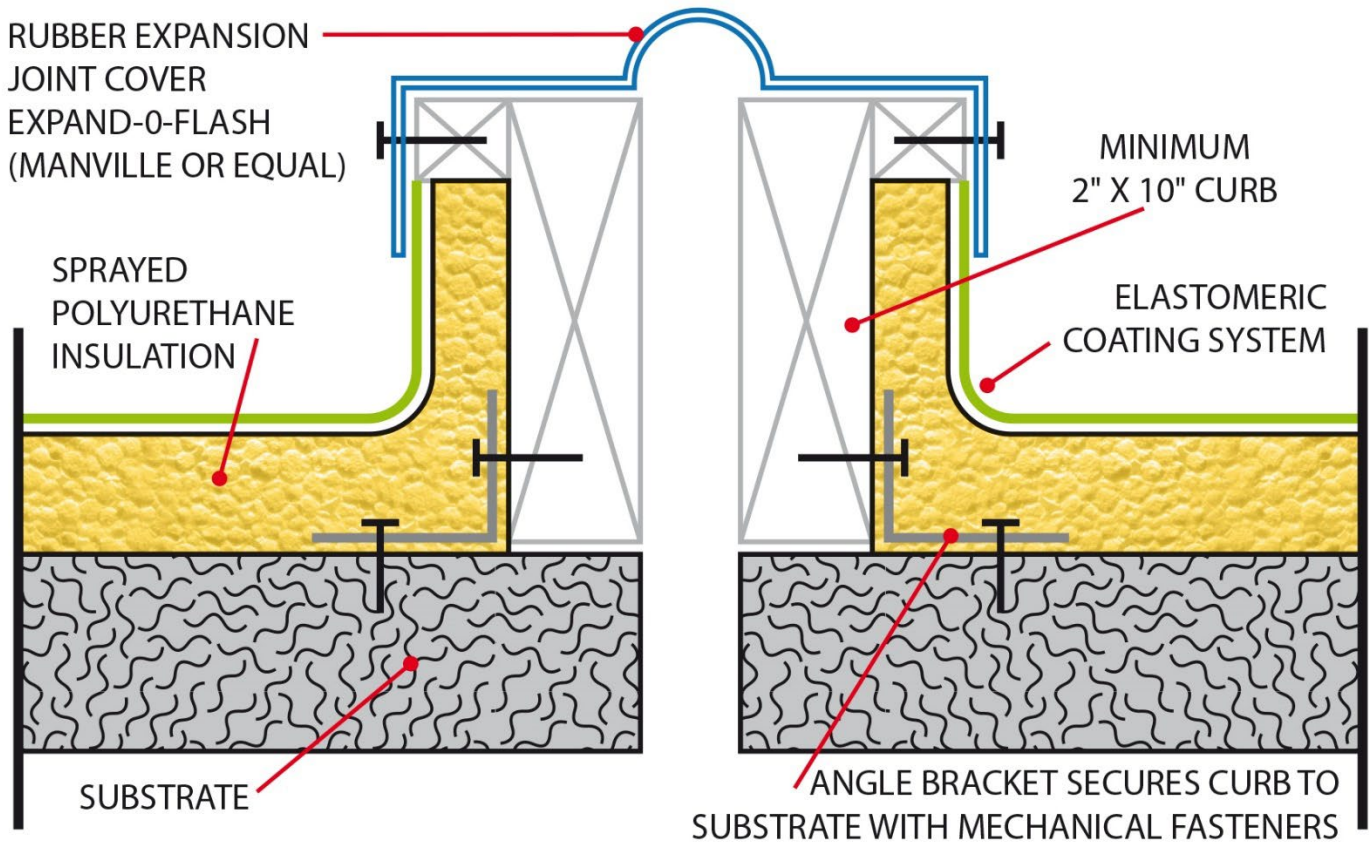

DETAIL 34, BUILDING EXPANSION JOINT

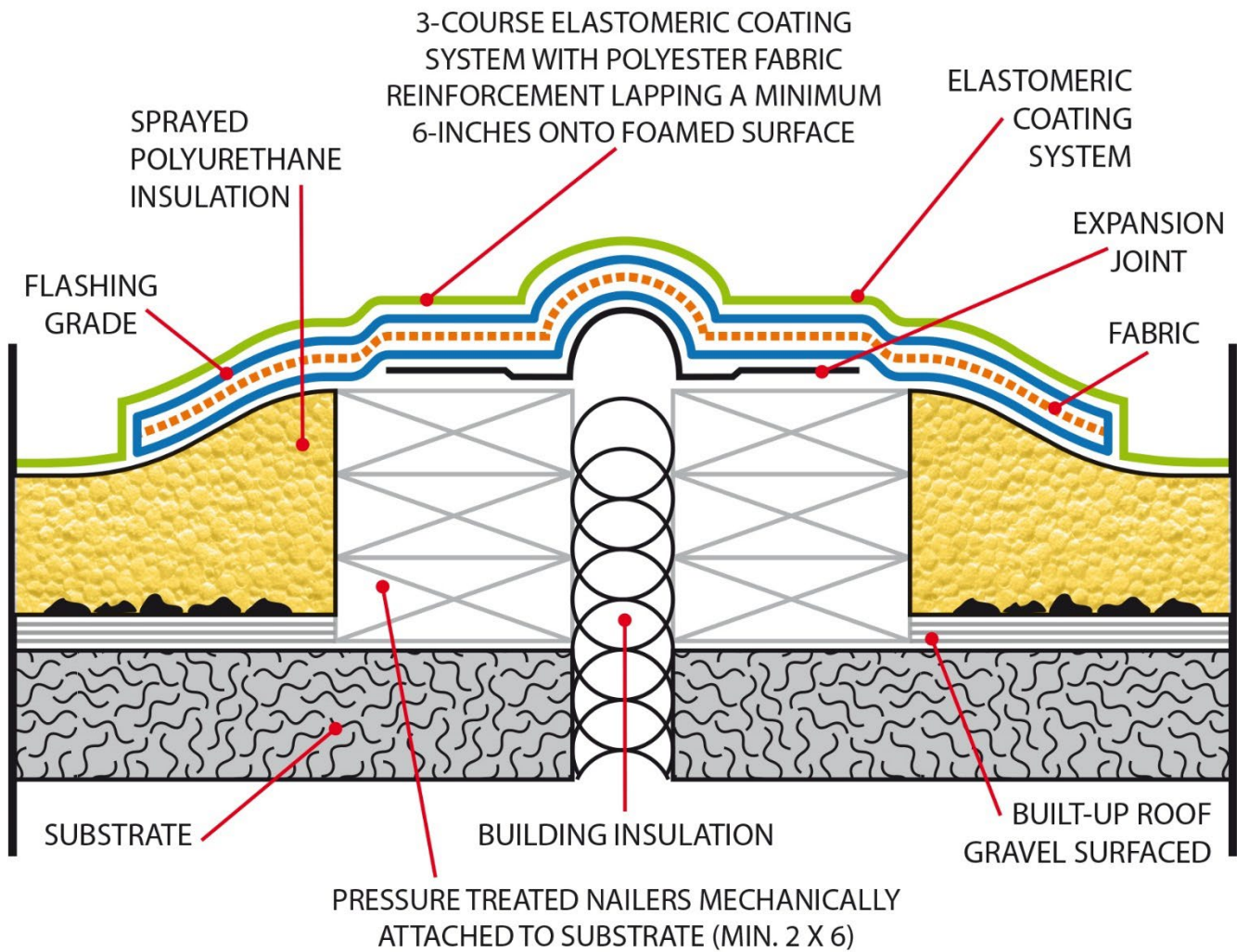

DETAIL 9, CONDUIT AND PIPE SUPPORT

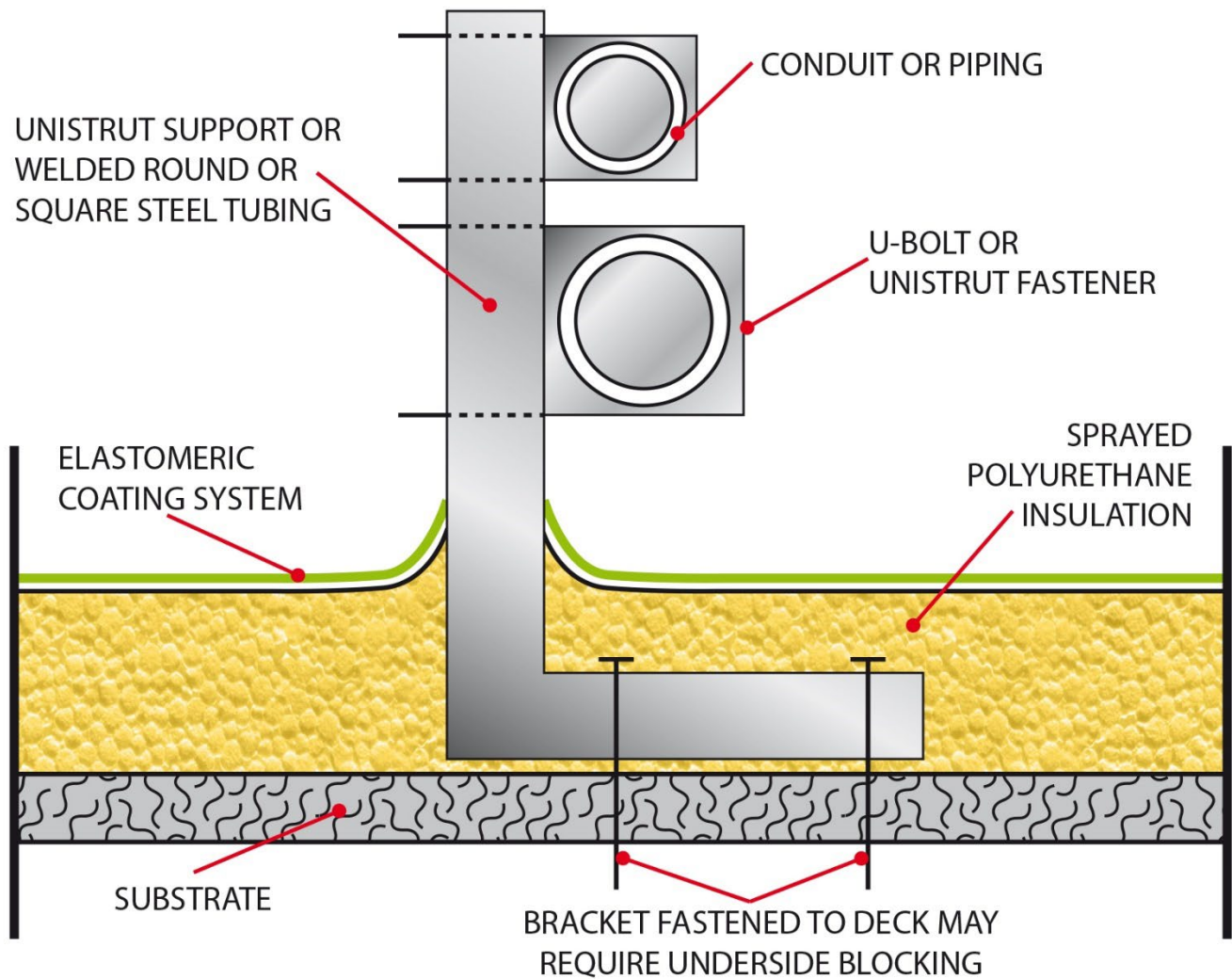



DETAIL 13, ELECTRICAL BOX / WALL MOUNT

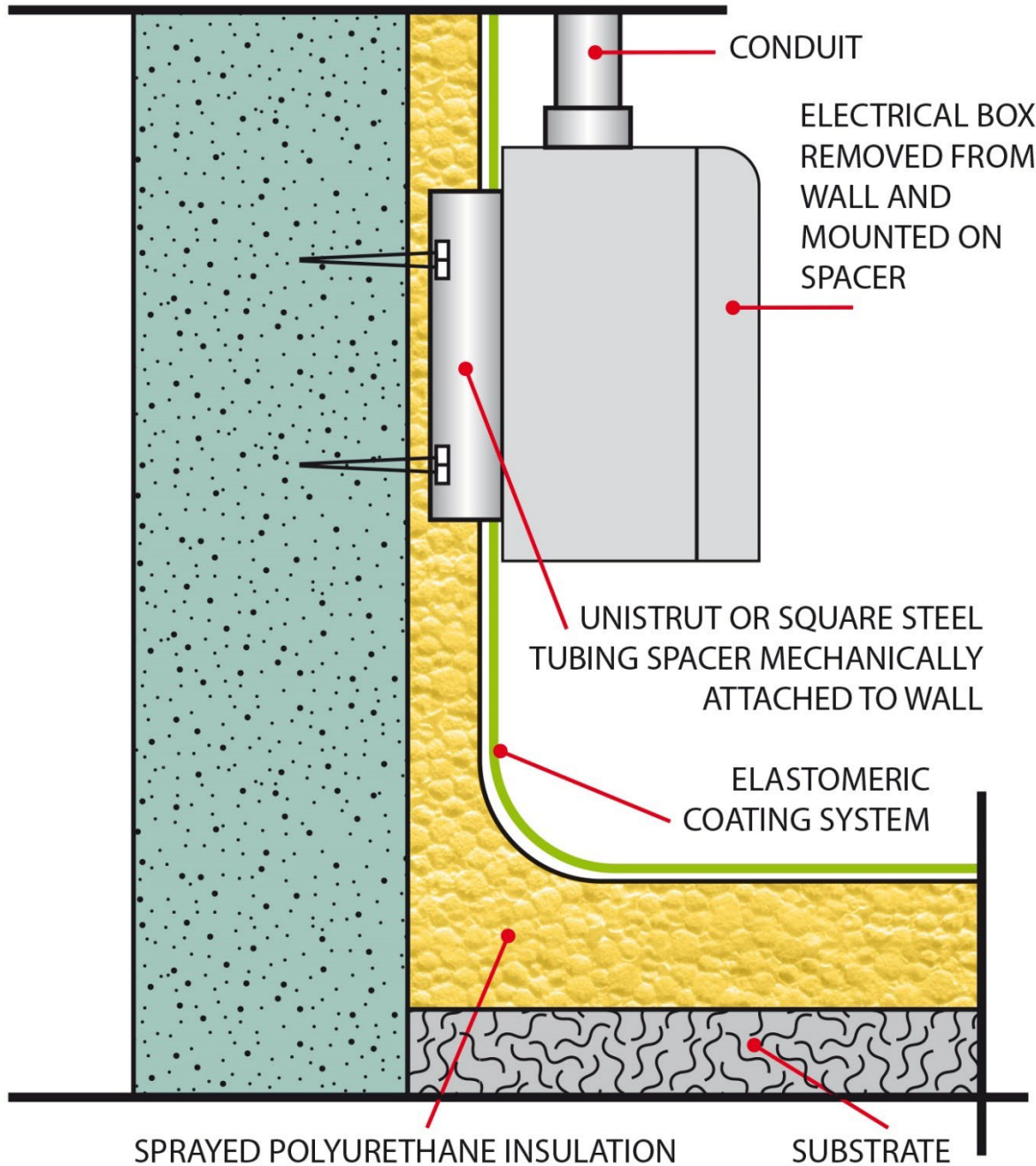

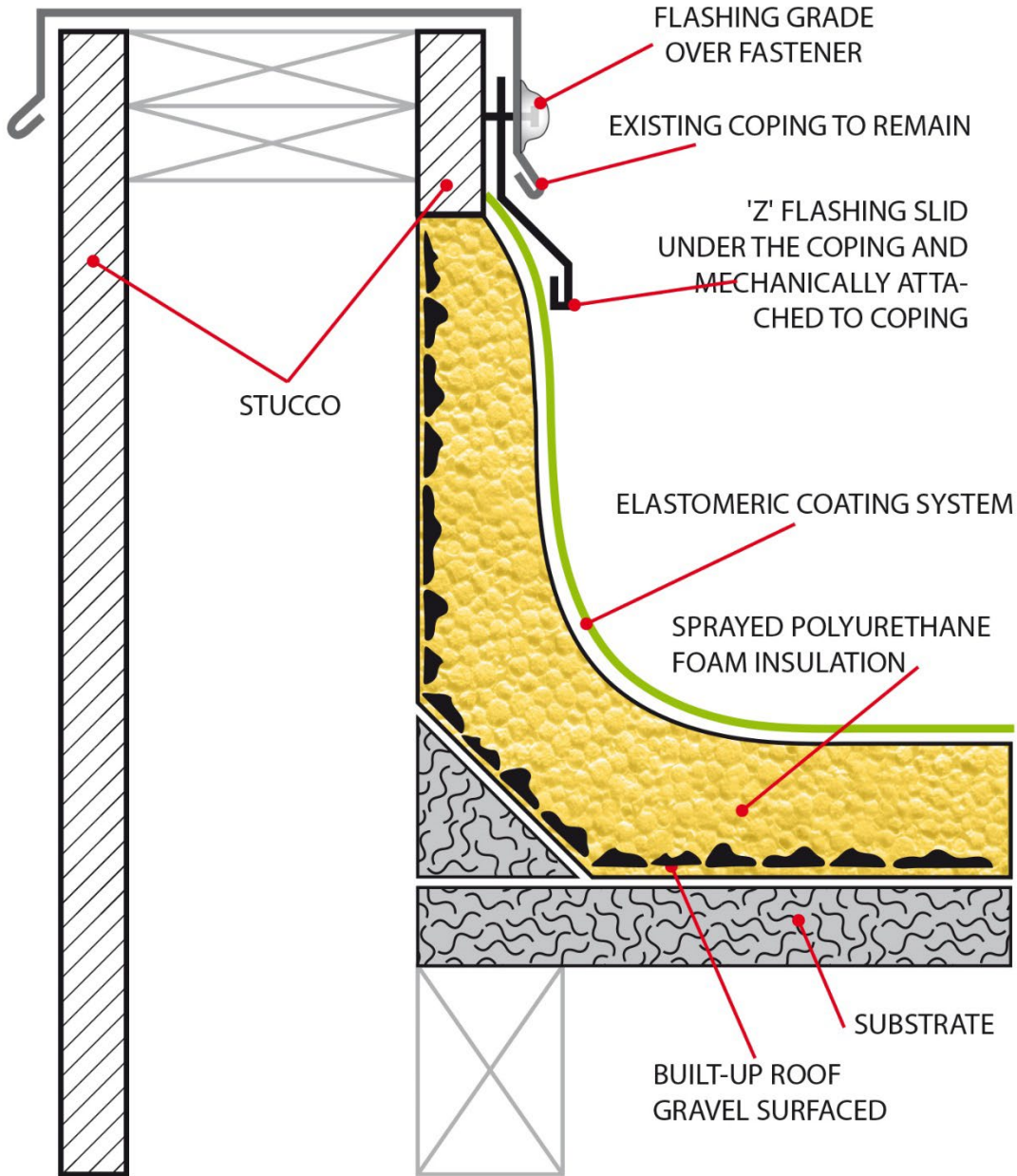

DETAIL 22, EXISTING PARAPET WALL/ COPING

DETAIL 29, EXISTING PARAPET WITH SURFACE MOUNT COUNTERFLASHING

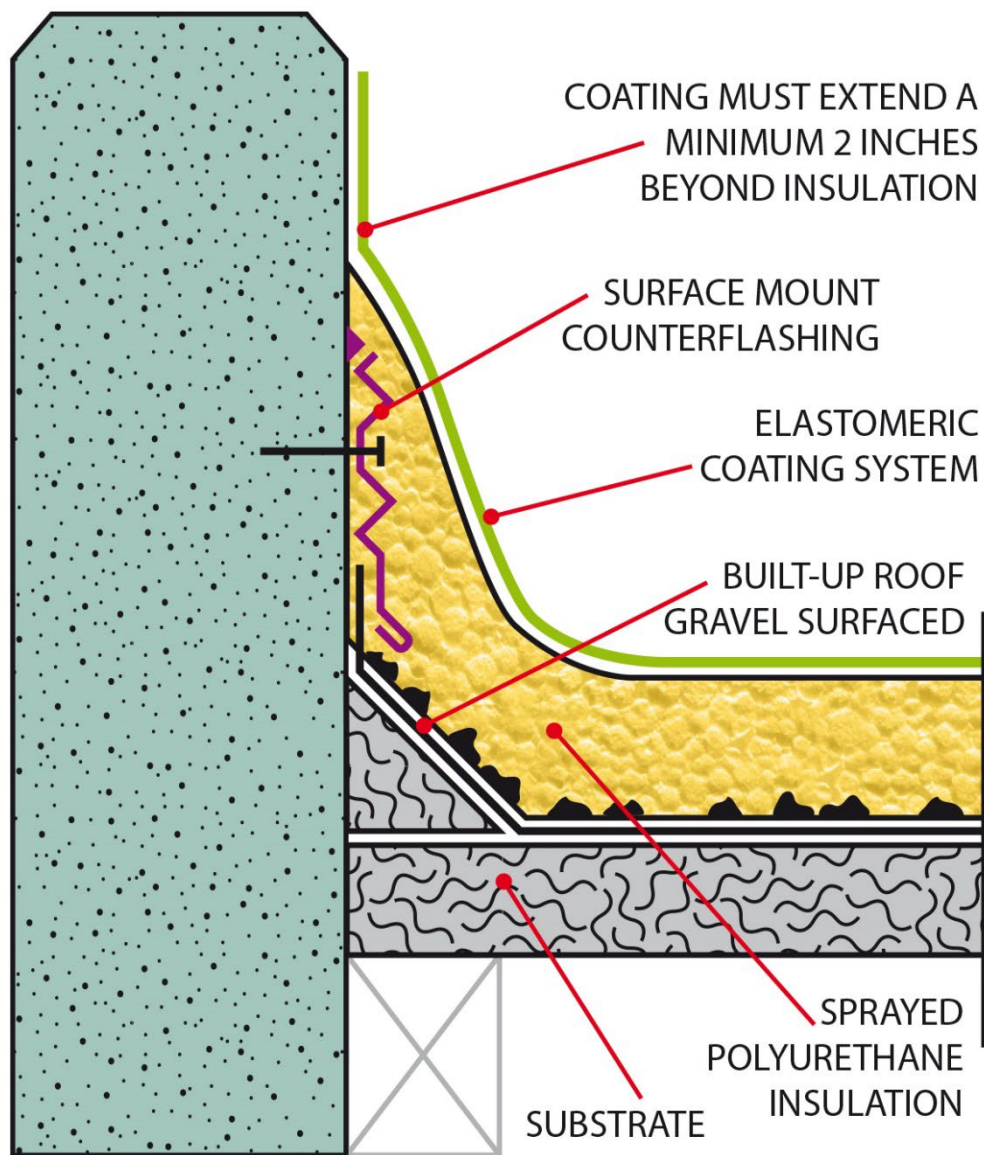

DETAIL 30, EXISTING STUCCO PARAPET WITH 'Z' BAR COUNTERFLASHING

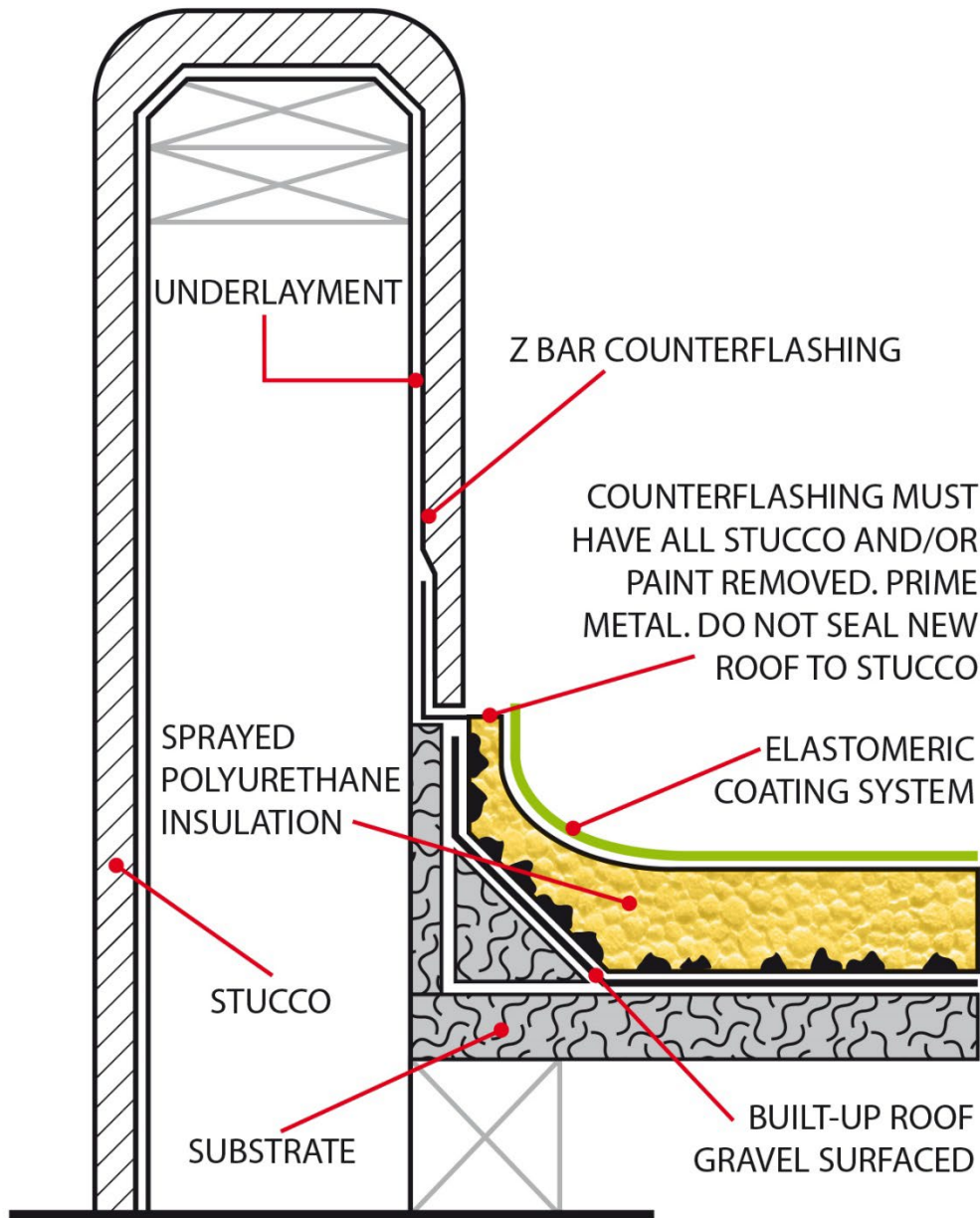

DETAIL 31-A, GUTTER / METAL ROOF

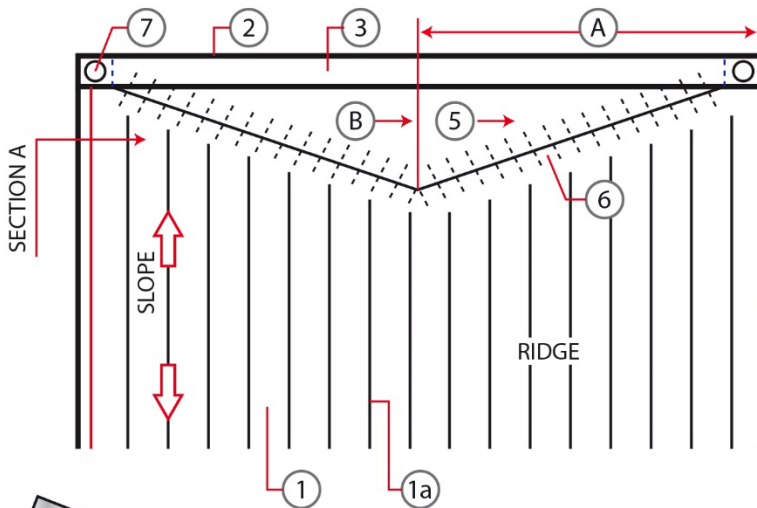

- 1** METAL CORRUGATED ROOF PANELS
- 1a** RAISED CORRUGATED RIB
- 2** ADJOINING BUILDING OR WALL
- 3** EXISTING GUTTER TO BE COVERED
- A** CRICKET HEIGHT IS DETERMINED FROM DISTANCE OF DRAIN OR SCUPPER TO CENTER OF ROOF, DIVIDED BY 3 EQUALS 'B' HEIGHT OF CRICKET (UP ROOF SLOPE). SLOPE OF CRICKET SHALL BE A MINIMUM OF 1/2-INCH IN 12 INCHES
- B** CRICKET CENTER LINE OR RIDGE FROM WALL UP SLOPE
- 4** 'L' METAL MECHANICALLY ATTACHED TO ADJOINING BUILDING OR WALL AND CORRUGATED ROOF DECK CONSTRUCTED FROM MINIMUM 22 GA. GALVANIZED MATERIAL
- 5** CRICKET FROM CENTER OF ROOF SLOPING TO DRAINS OR SCUPPERS
- 6** TRANSITION FROM CORRUGATED METAL ROOF TO CRICKET SHALL HAVE RIDGES GROUND SMOOTH TO PROVIDE A SMOOTH CHANNEL (MINIMUM 36-INCHES WIDE) WITHOUT OBSTRUCTIONS OR RIDGES FOR WATER TO EXIT ROOF. EXCESS FOAM ON RIBS SHALL BE GROUND-OFF AFTER BASE FOAM APPLICATION IS APPLIED PRIOR TO APPLYING CRICKET FOAM TO PROVIDE A "SKINNED" FOAM SURFACE ... OR, GROUND FINISHED FOAM SHALL RECEIVE ADDITIONAL COATING PER THE SPECIFICATIONS
- 7** ROOF DRAIN
- 8** SPRAYED POLYURETHANE INSULATION
- 9** ELASTOMERIC COATING SYSTEM

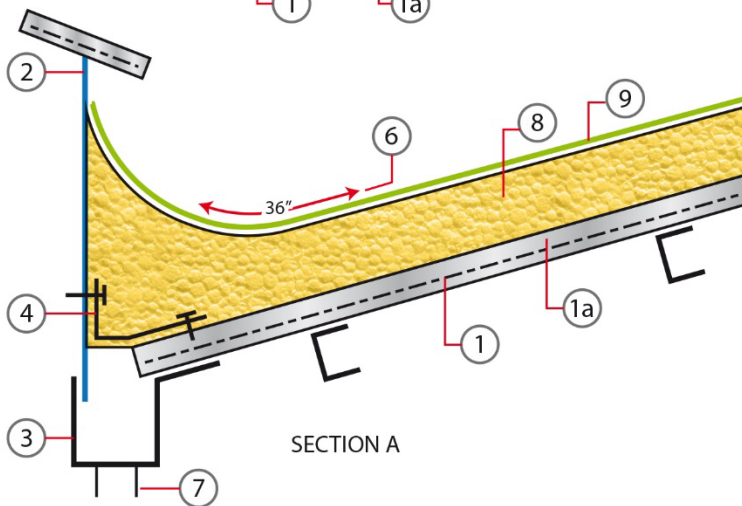



DETAIL 8, GUY WIRE STANCHION

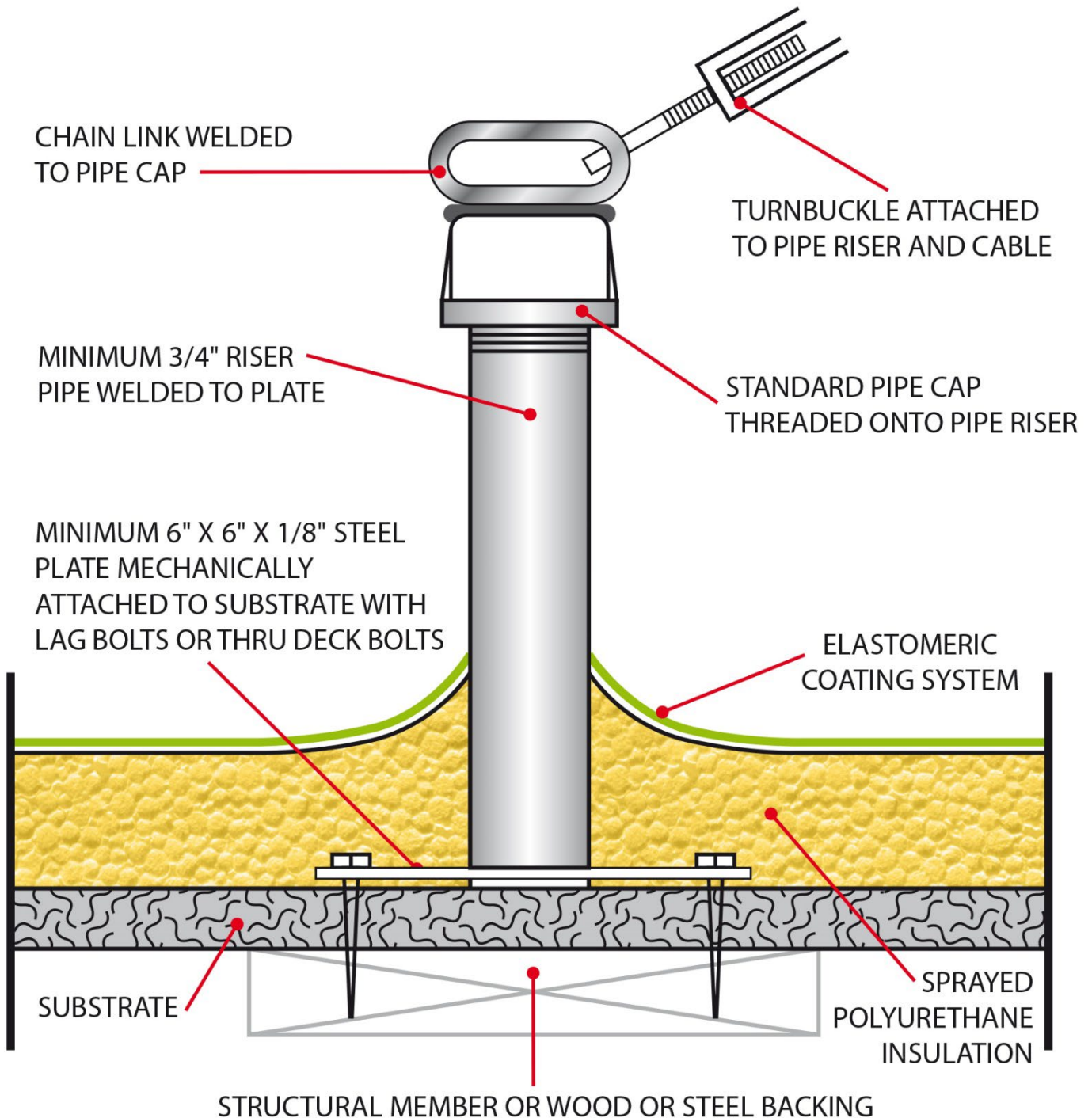

DETAIL 23, HOT STACK STORM COLLAR

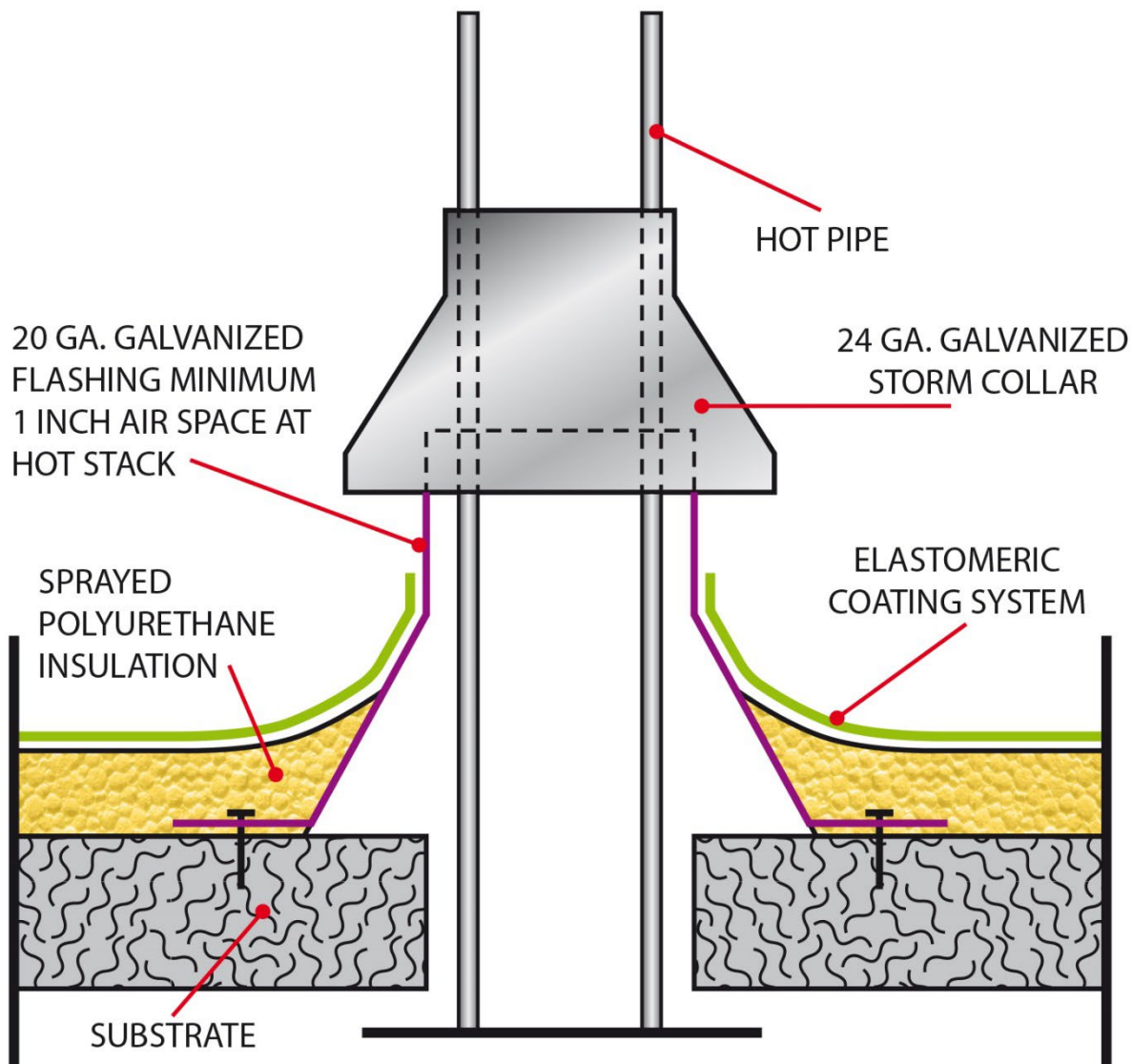

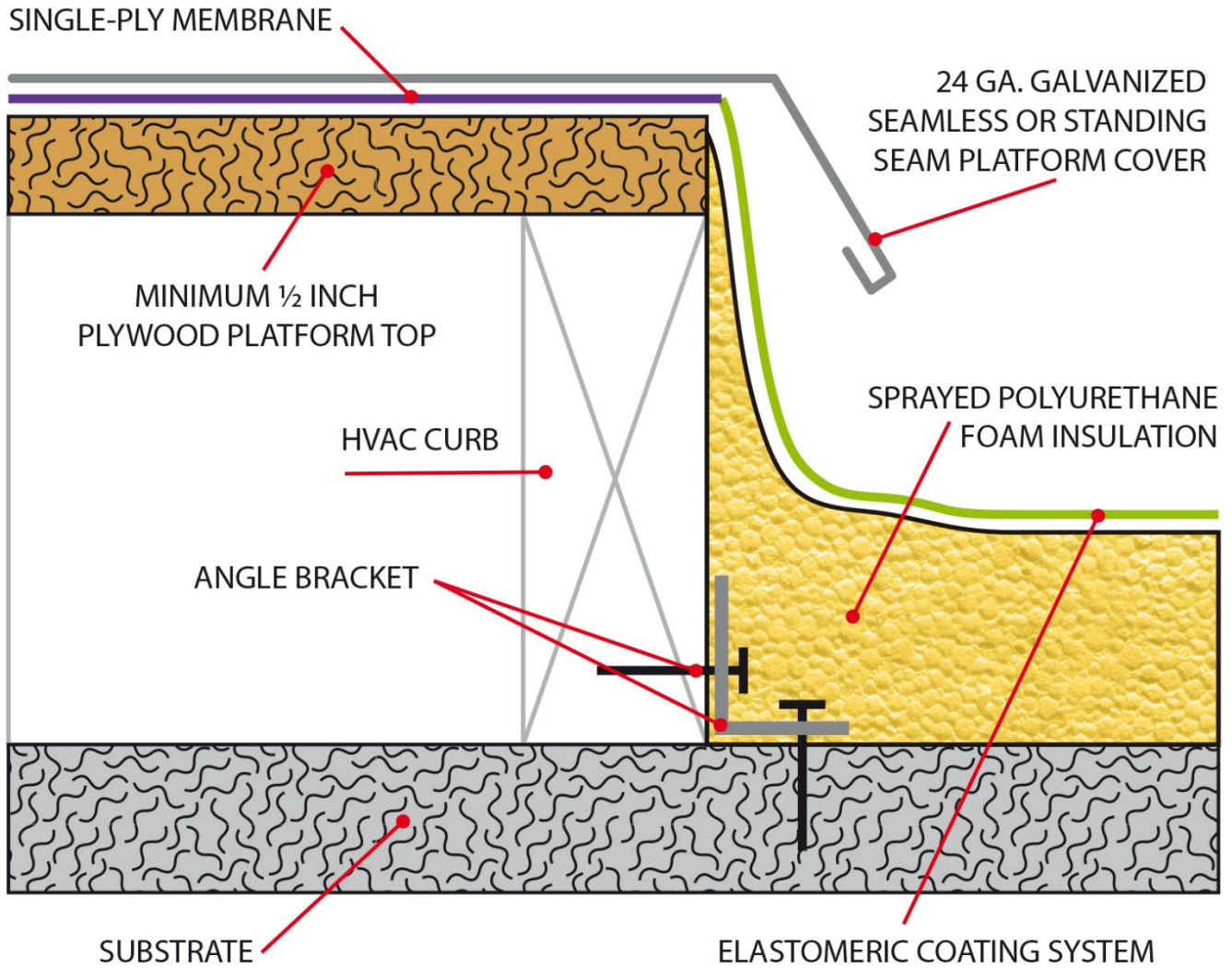

DETAIL 1, HVAC / EQUIPMENT PLATFORM

DETAIL 11, INTERNAL GUTTER

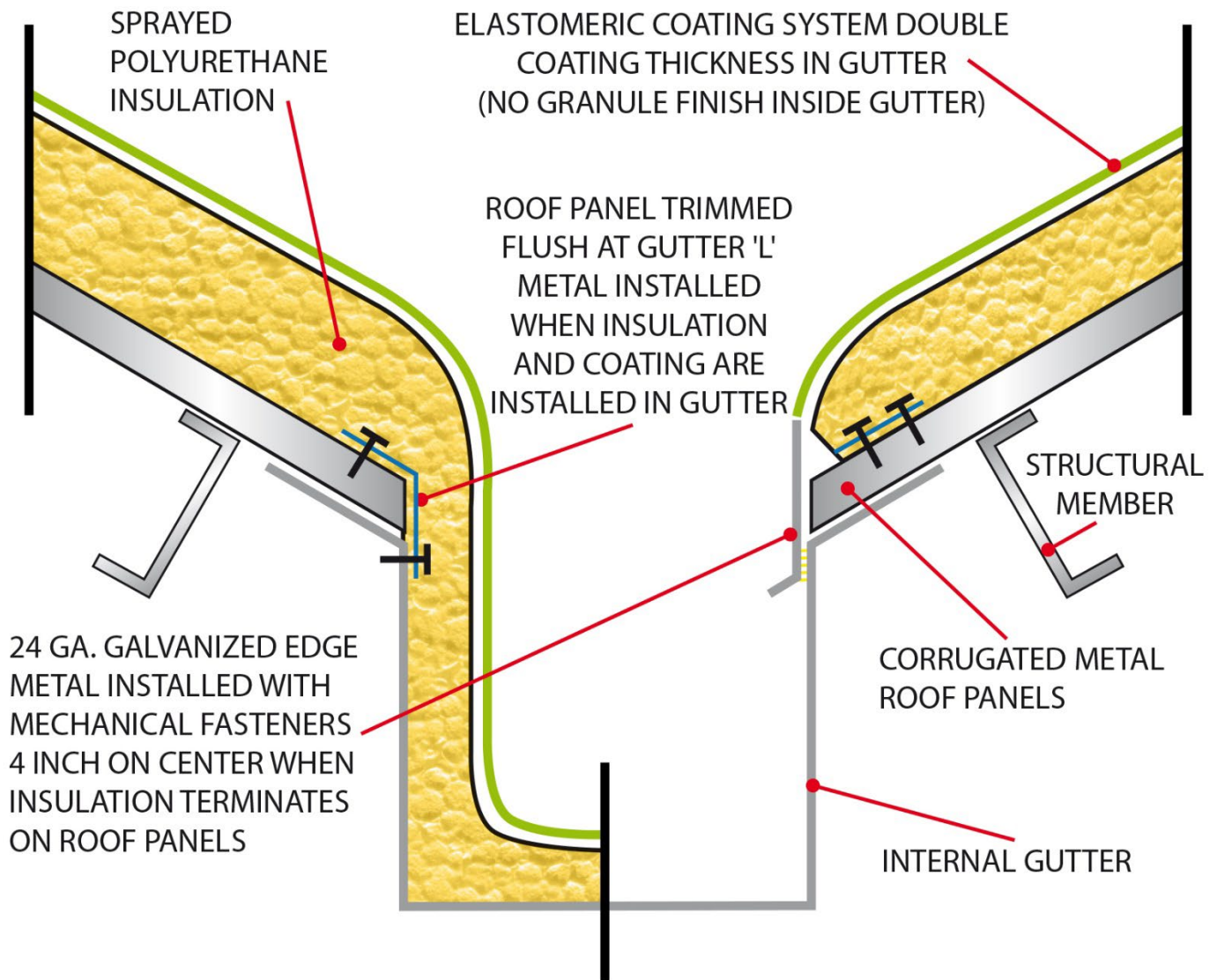

DETAIL 2, INTERNAL ROOF DRAIN

BUILT-UP ROOFING REMOVED A MINIMUM OF 12 INCHES FROM THE DRAIN BOWL FLANGE. EDGE OF BUR TO BE MECHANICALLY ATTACHED TO SUBSTRATE

ELASTOMERIC COATING SYSTEM, DOUBLE COATING THICKNESS AROUND DRAIN AREA

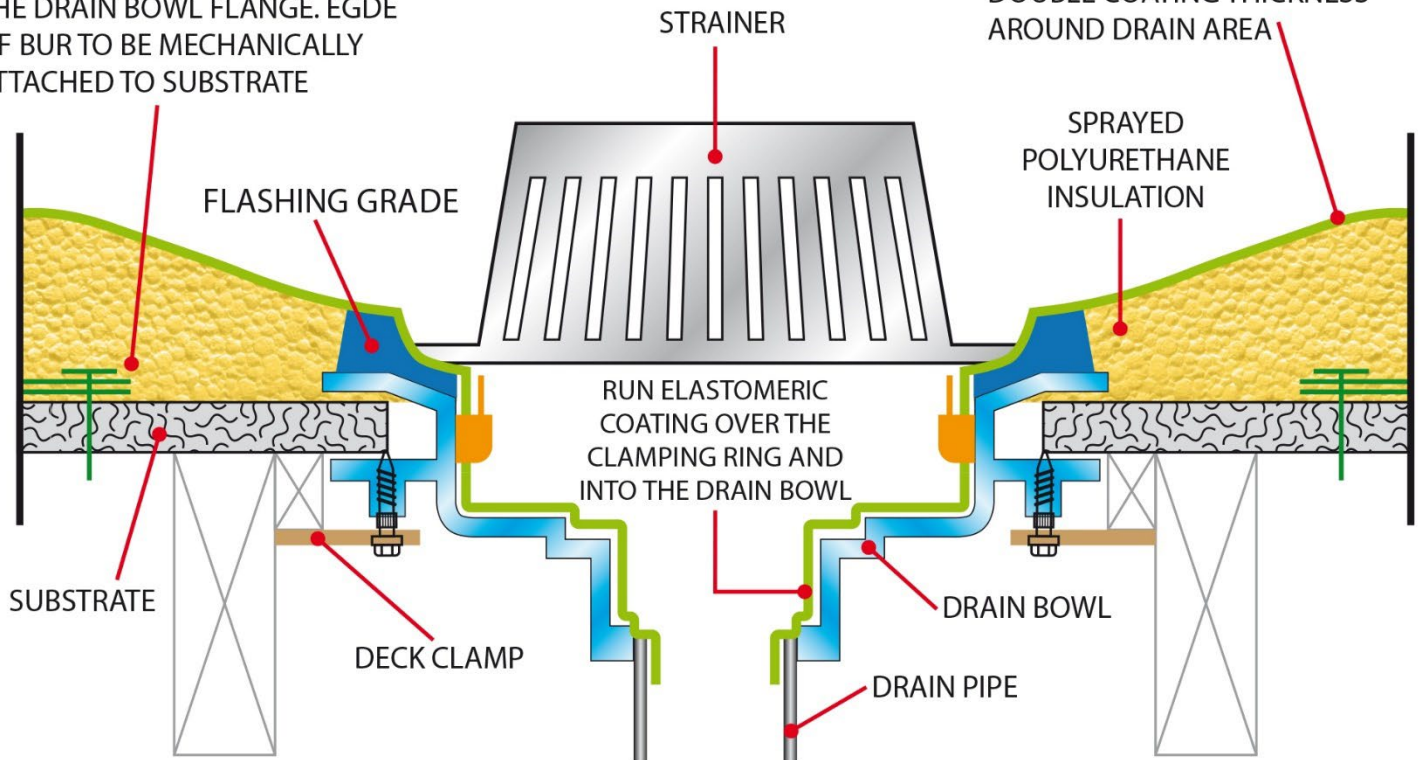

DETAIL 3, LOWER ROOF ADJOINING WALL

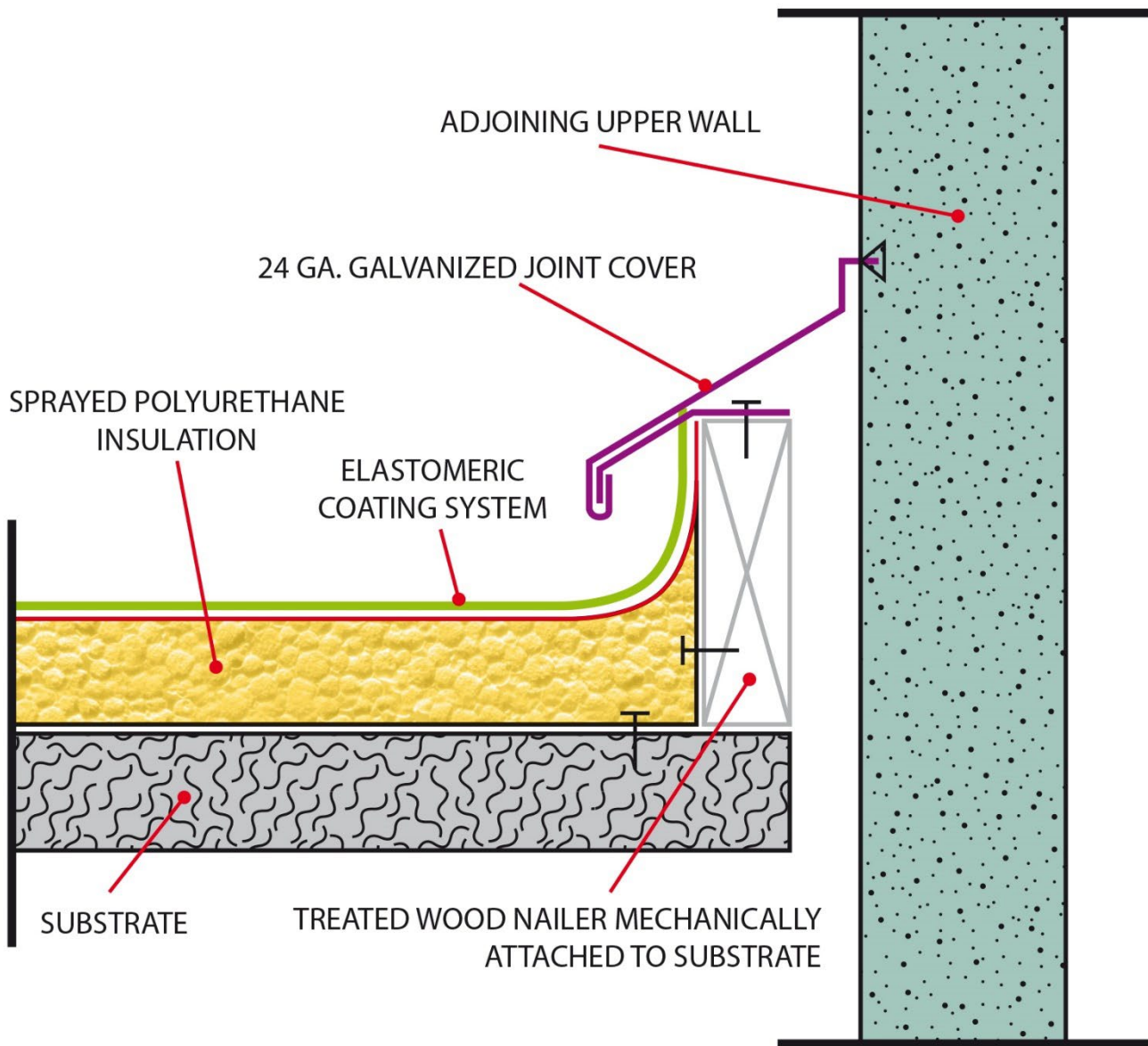

DETAIL 37, LOWER ROOF / UPPER ROOF NEW EDGE METAL

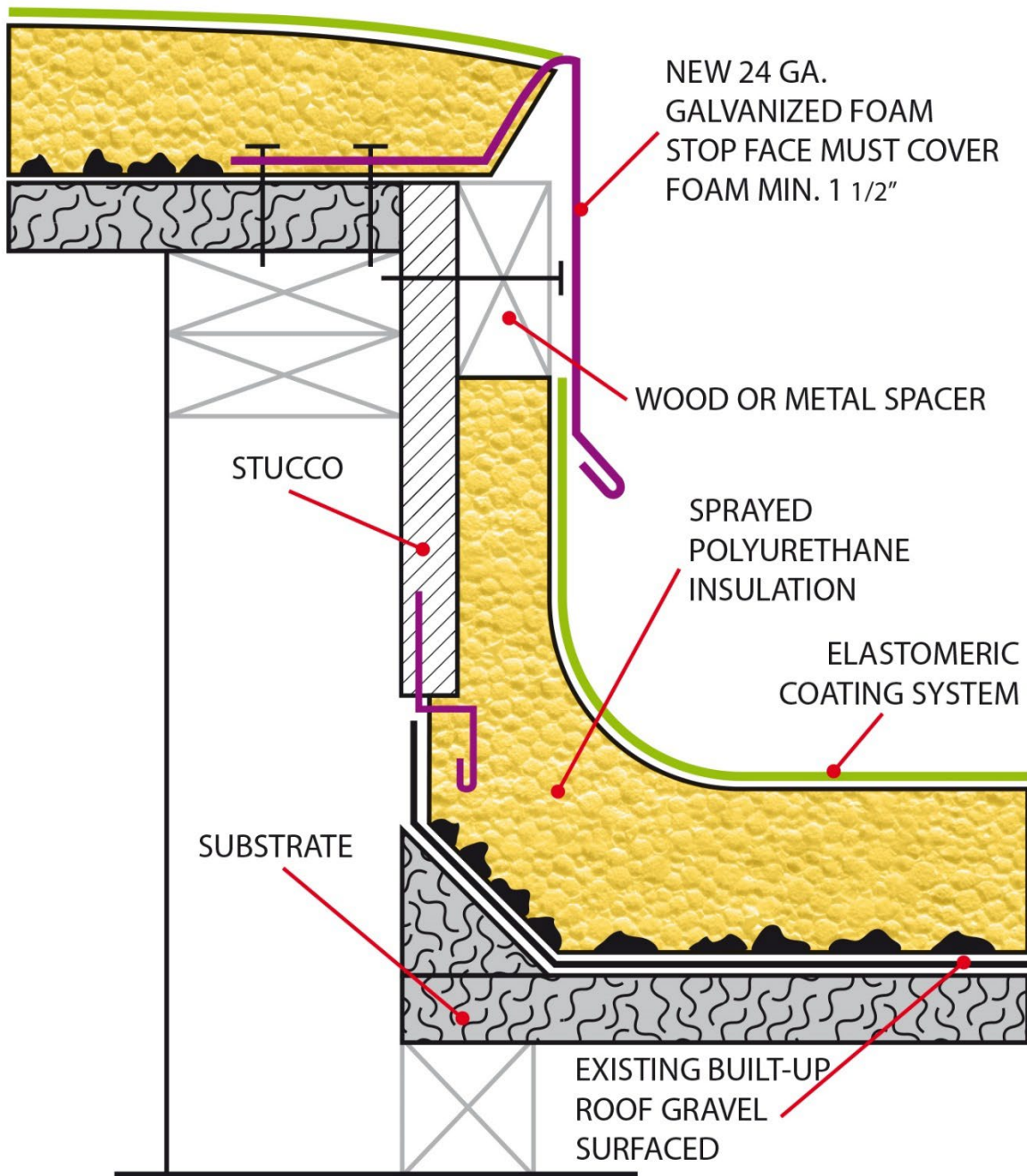

DETAIL 20, LOWER ROOF / UPPER WALL

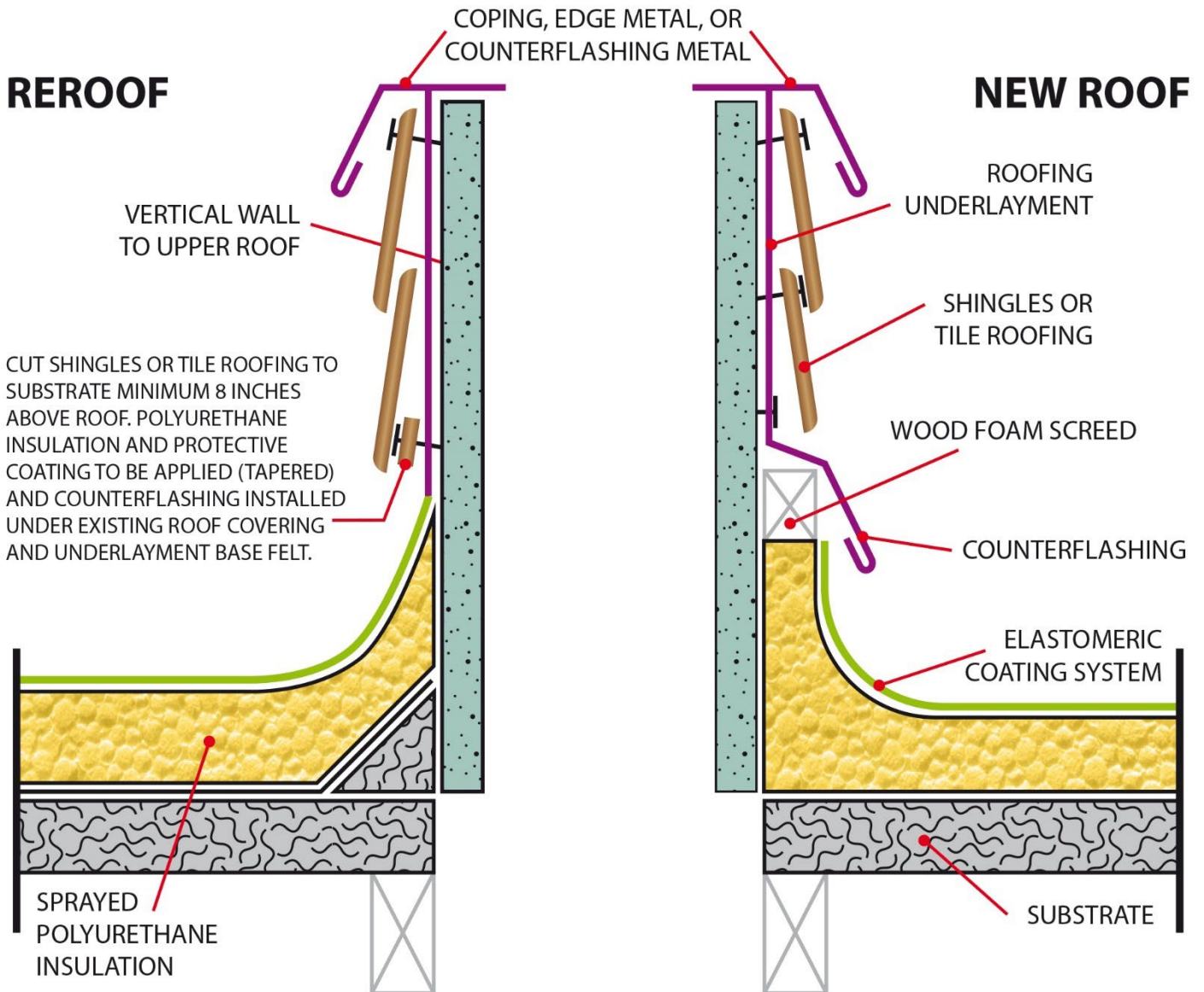

DETAIL 28, MOISTURE RELIEF VENT

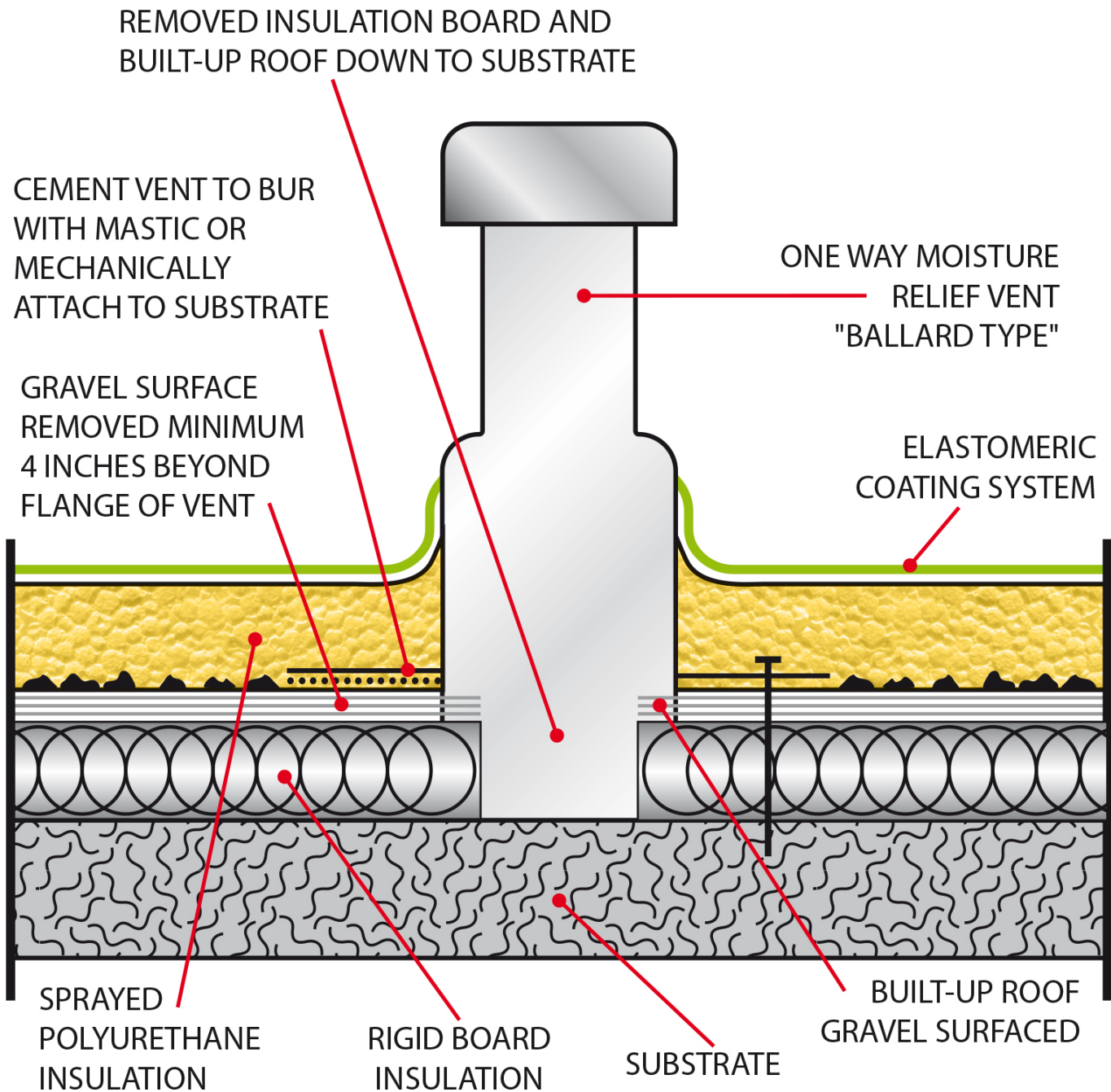



DETAIL 32, NEW FOAM STOP OVER EXISTING COPING

24 GA. GALVANIZED FOAM STOP 3/4-INCH
MINIMUM RISE INSTALLED OVER EXISTING
COPING MECHANICALLY ATTACHED

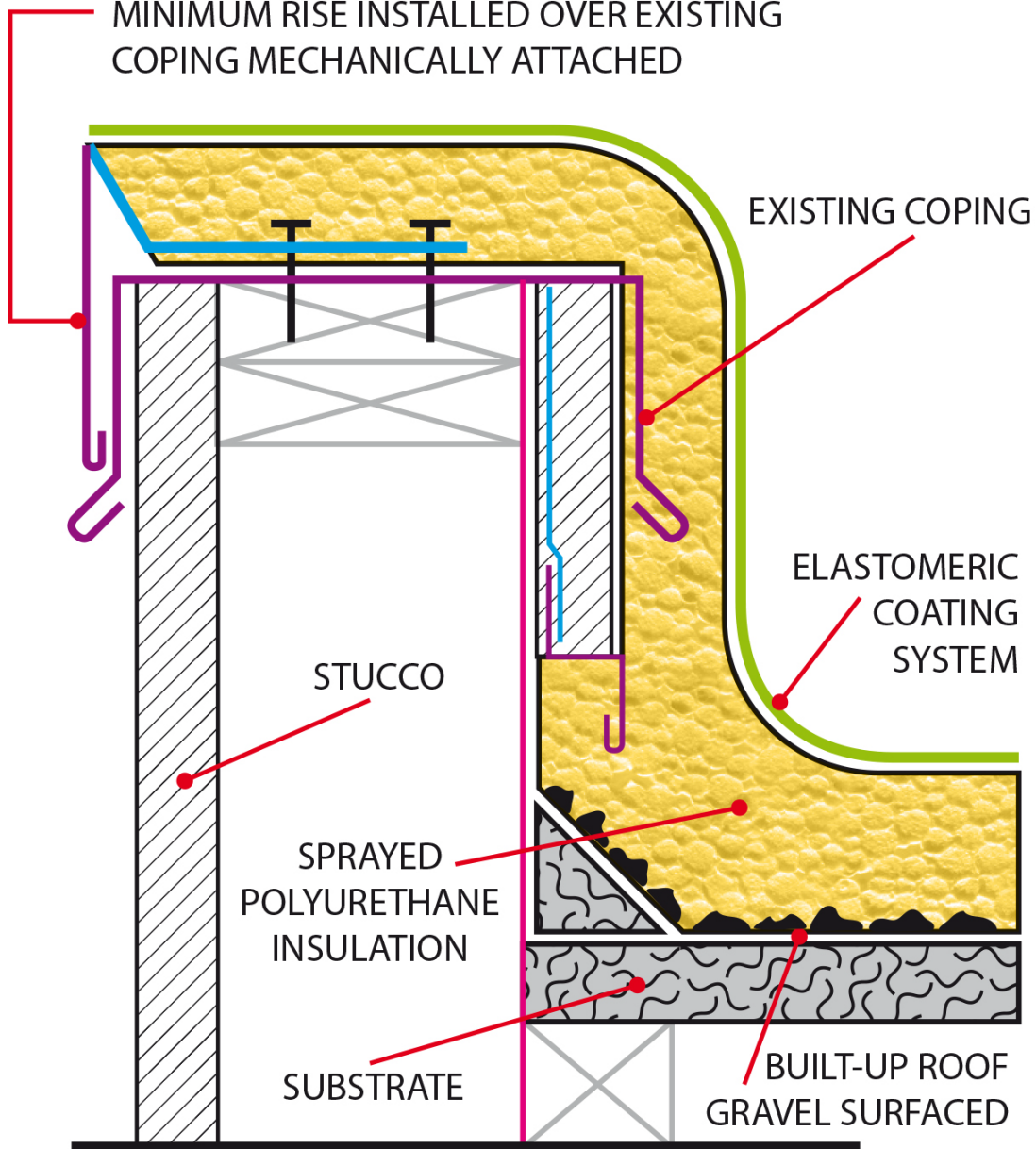

DETAIL 24, OVERHEAD PIPE / CONDUIT SUPPORT

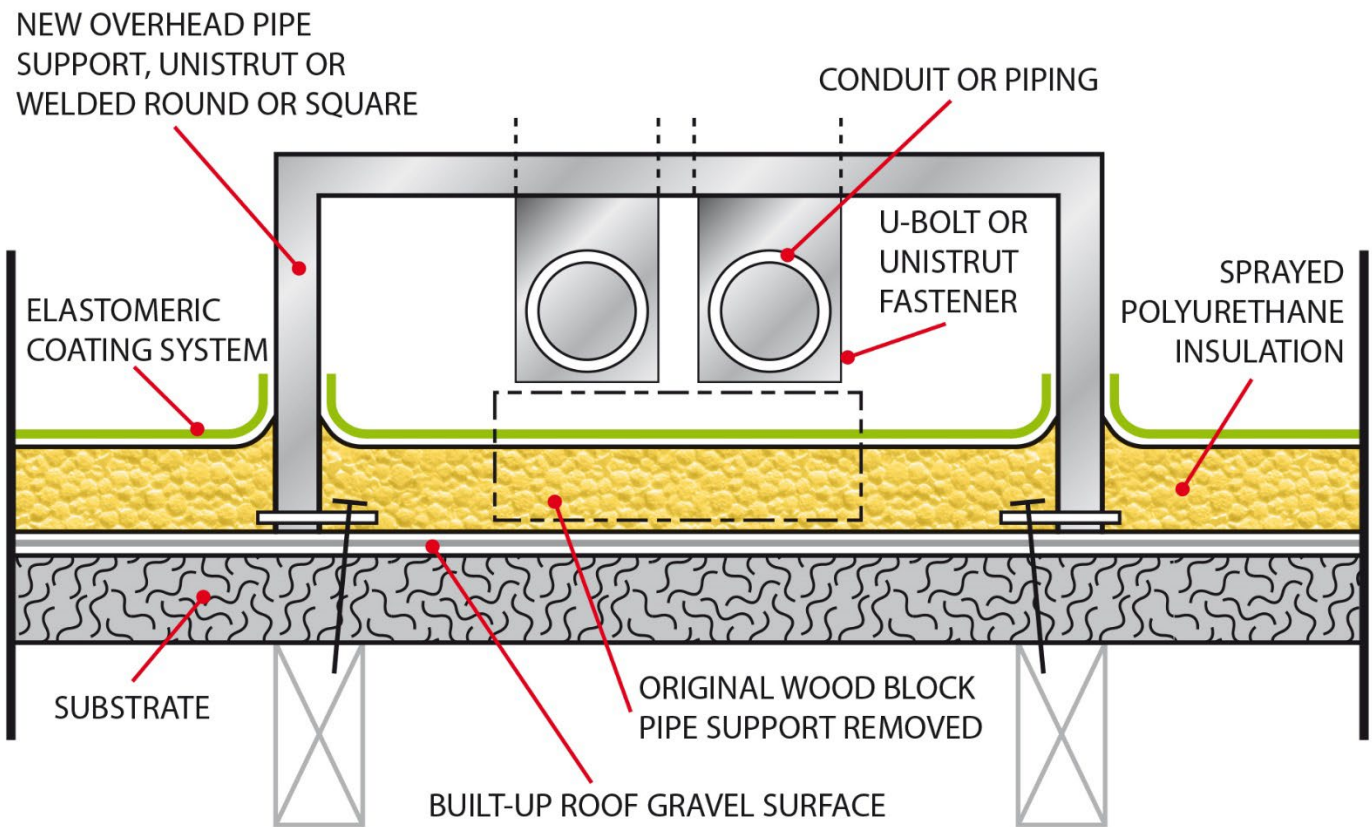

DETAIL 21, PARAPET WALL / COUNTERFLASHING

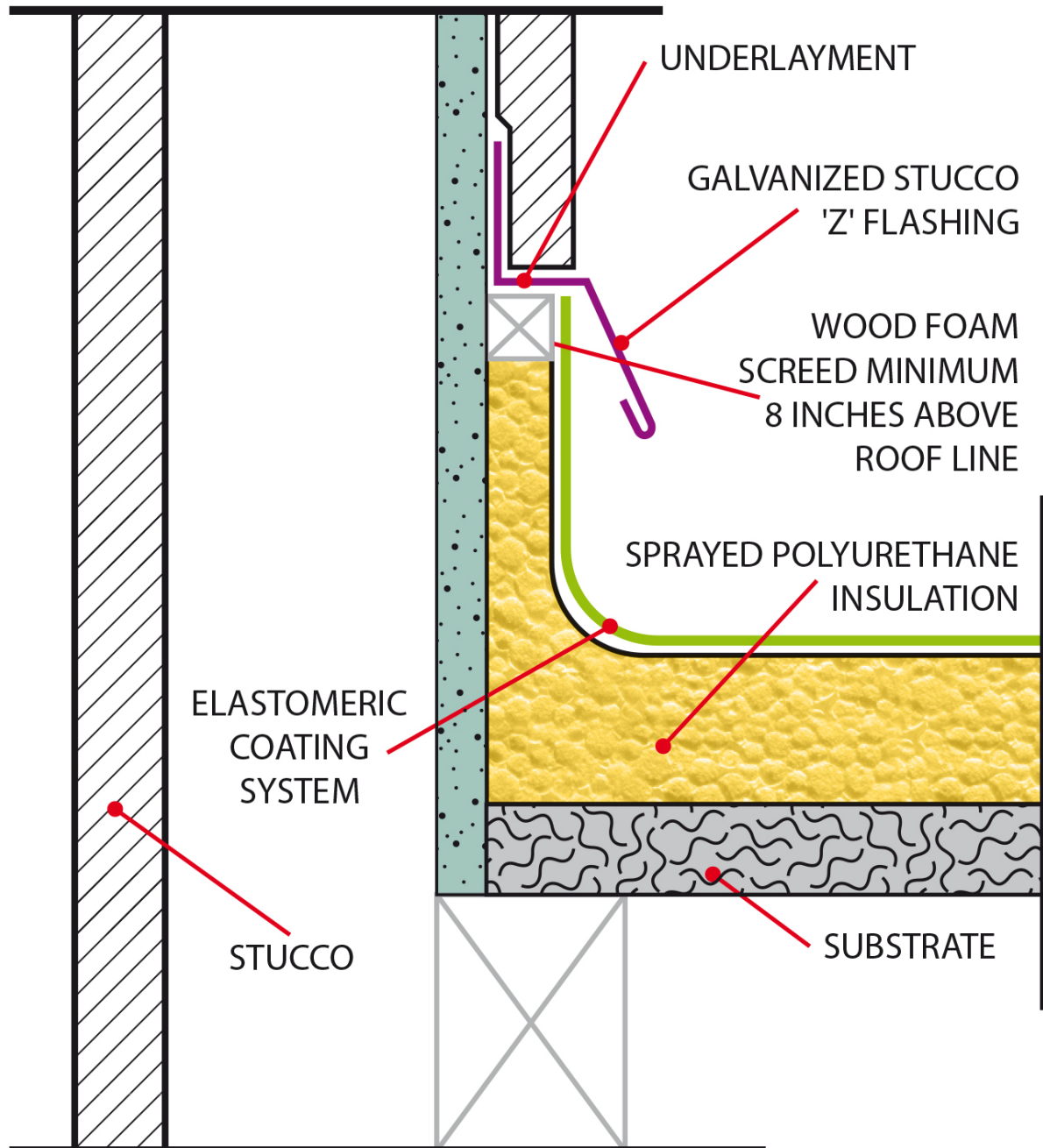

DETAIL 4, PARAPET WALL / NO METAL

ELASTOMERIC COATING SYSTEM DOUBLE THICKNESS ON GROUND/CUT FOAM

POLYURETHANE INSULATION APPLIED TO TOP OF WALL AND GROUND SMOOTH AT 45 DEGREE ANGLE OR TO PARAPET WALL CHAMFER ANGLE

ELASTOMERIC COATING SYSTEM

SUBSTRATE

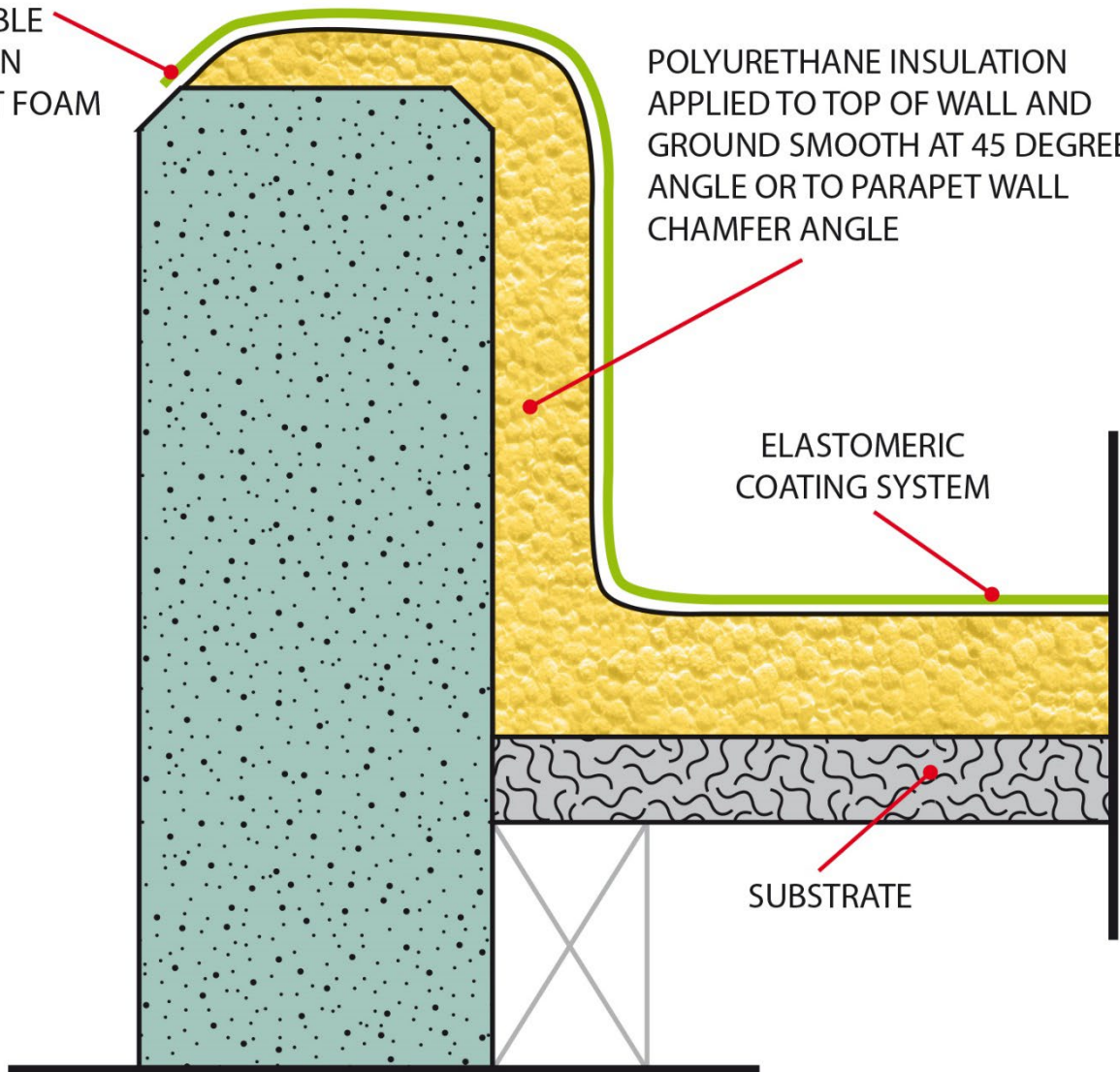



24 GA. GALVANIZED EDGE METAL
MECHANICALLY ATTACHED WITH CONCRETE
SCREWS OR EXPANDING FASTENERS
MINIMUM OF 9 INCHES ON CENTER

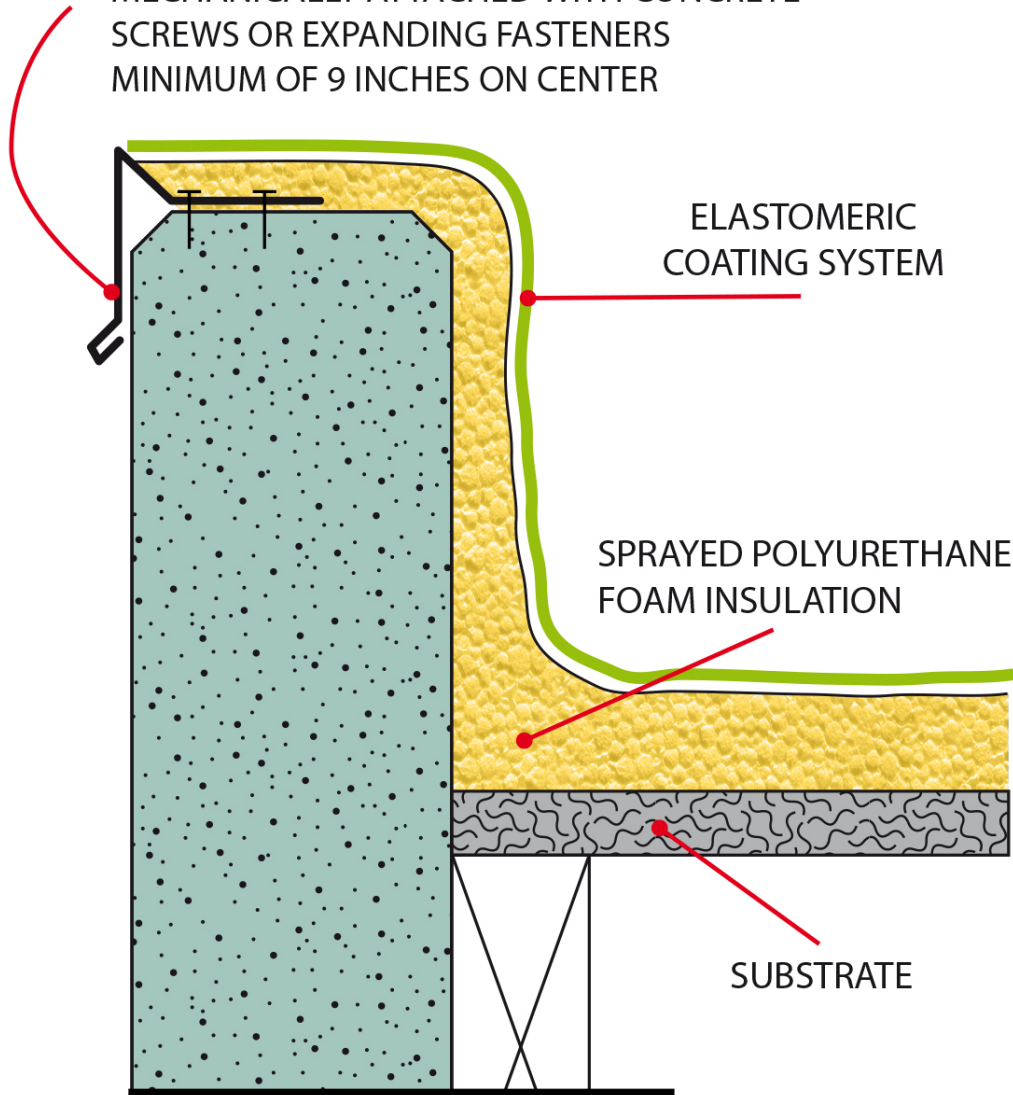

DETAIL 5

PARAPET WALL/ PERIMETER EDGE METAL FLASHING

DETAIL 6, PARAPET WALL / WITH COPING

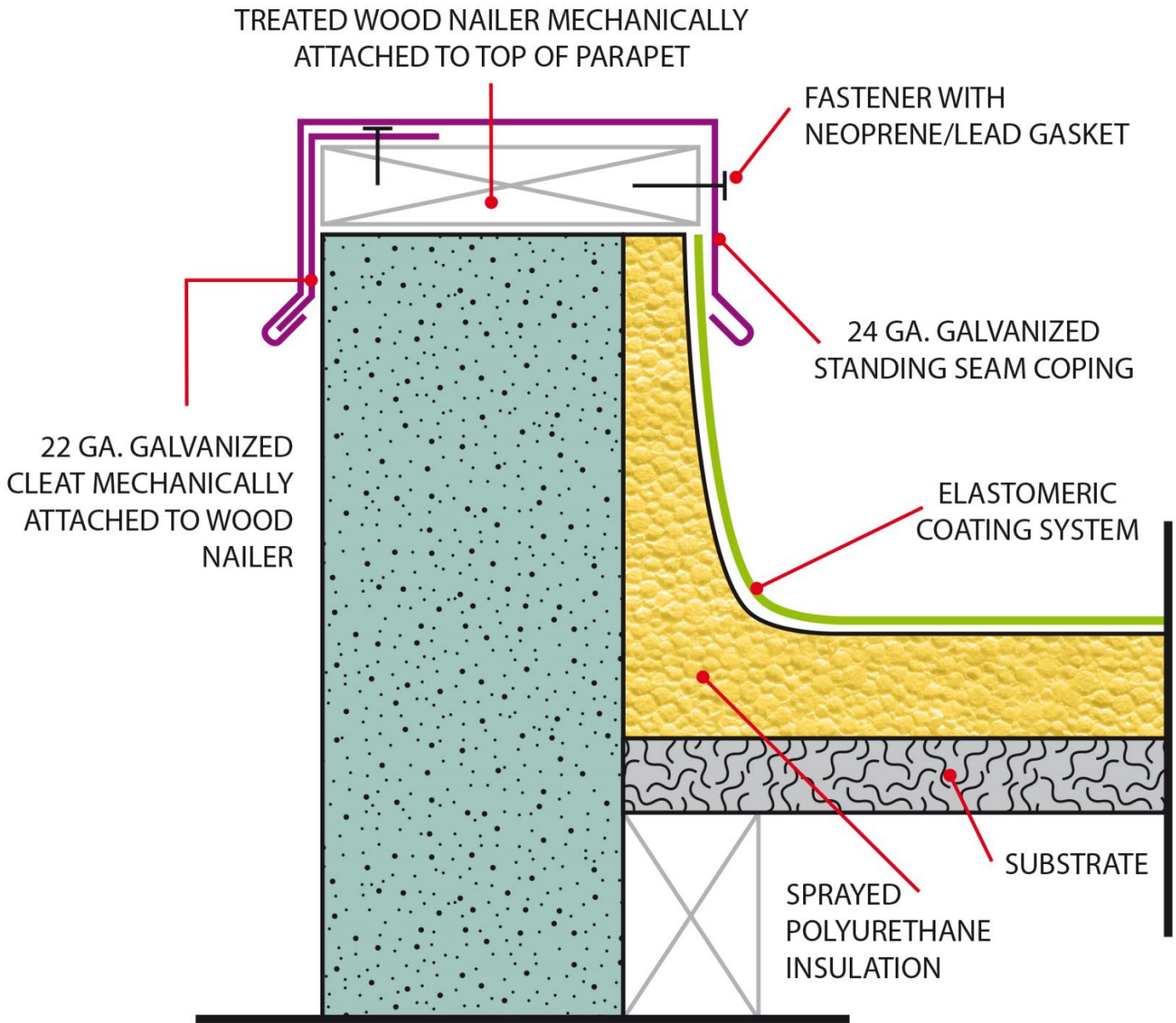

DETAIL 17, PERIMETER EDGE METAL FLASHING RAISED EDGE

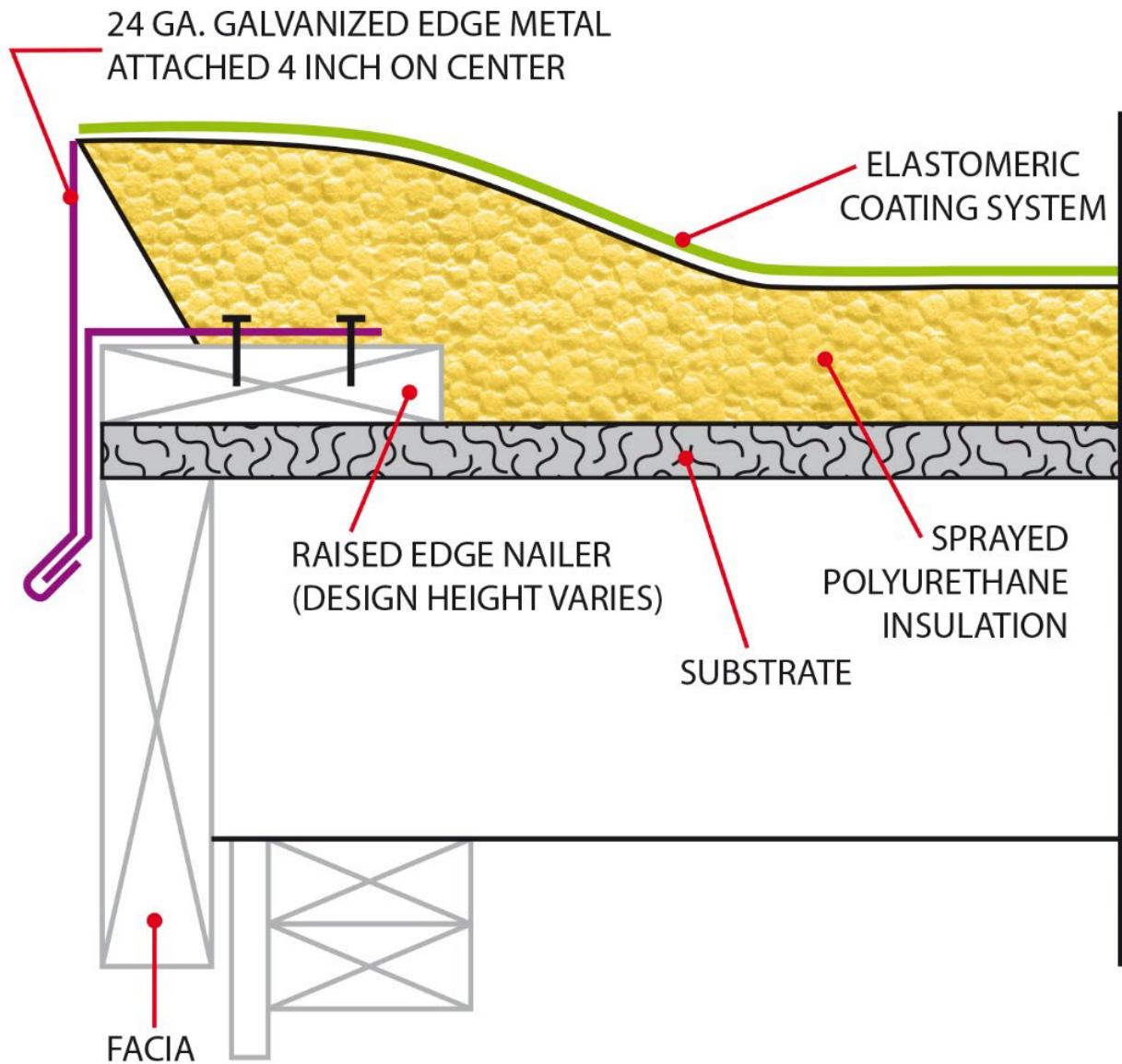

DETAIL 18, PIPE PENETRATION

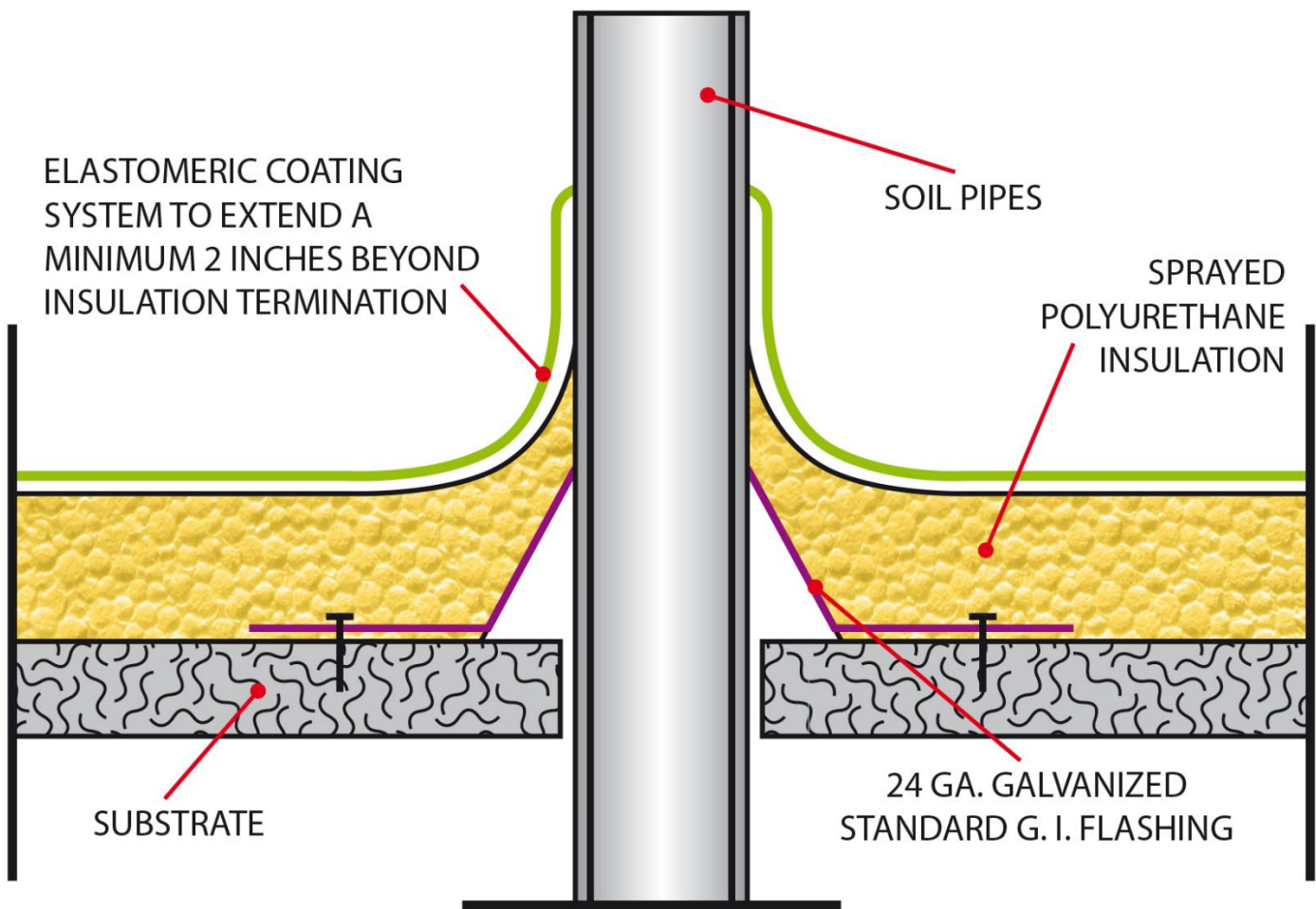

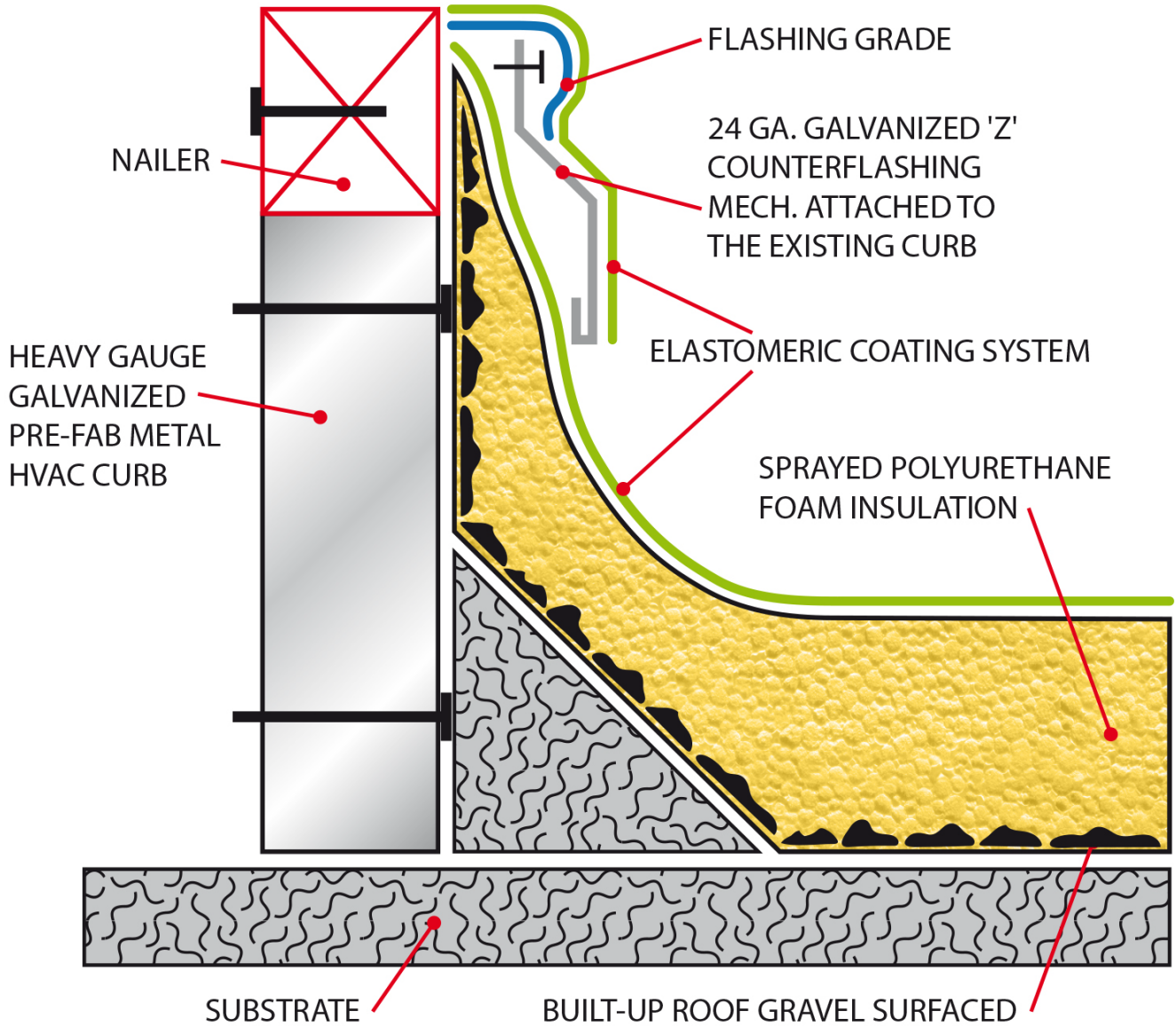

DETAIL 33, PRE-FAB METAL A/C CURB EXISTING BUR

DETAIL 25, RAISED SITE SCREEN MOUNT

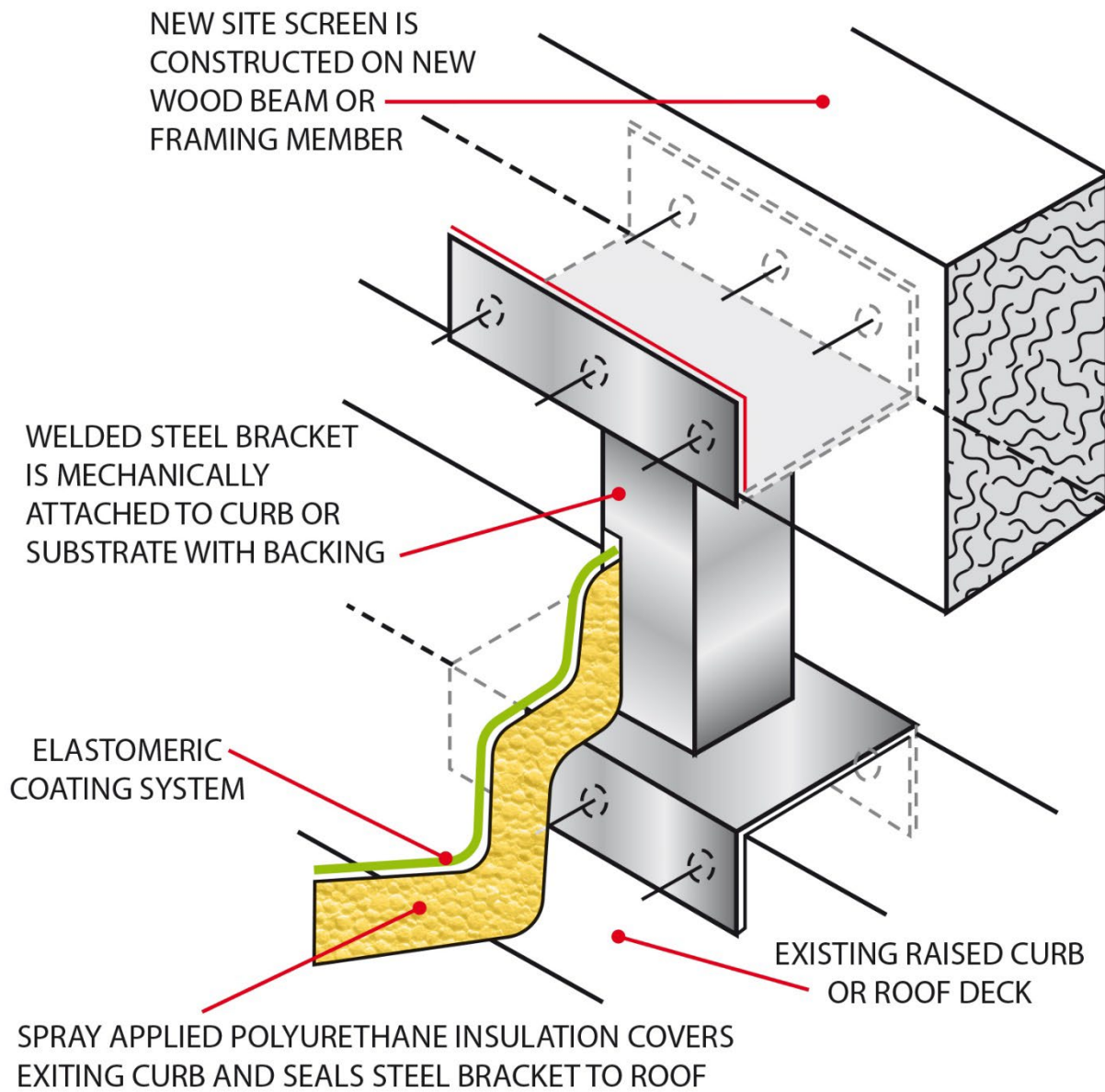

DETAIL 27, SHINGLE OR TILE "TIE-IN"

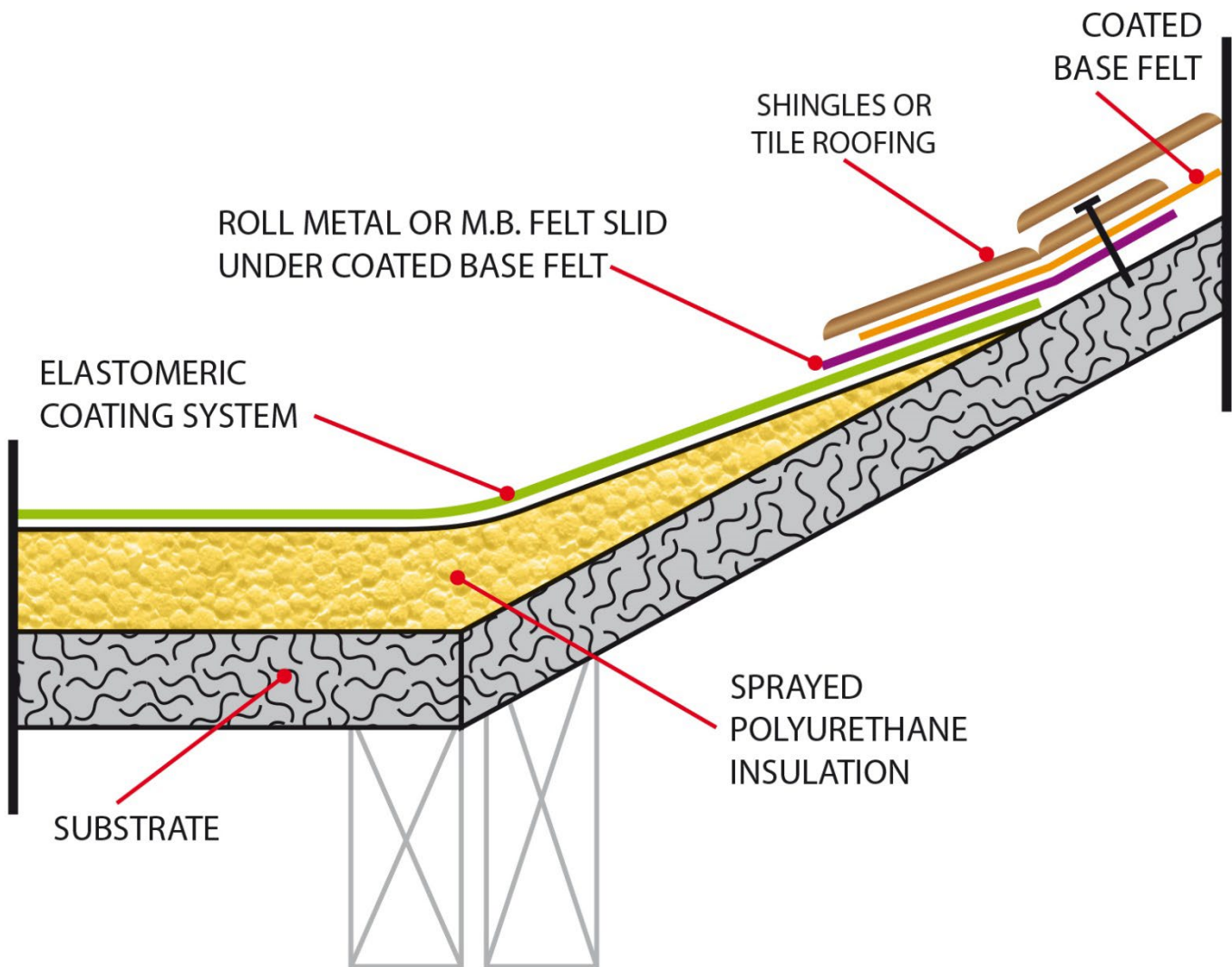

DETAIL 26, SITE SCREEN MOUNTING BLOCKS

WOOD BLOCKING SHALL BE A MINIMUM 4" X 6" TREATED D.F. OR REDWOOD LAGGED INTO ROOF DECK

24 GA. GALVANIZED BLOCK COVERS WITH ALL JOINTS SOLDERED 2" LARGER ALL DIMENSIONS WITH 1 1/2. INCH TURNDOWN

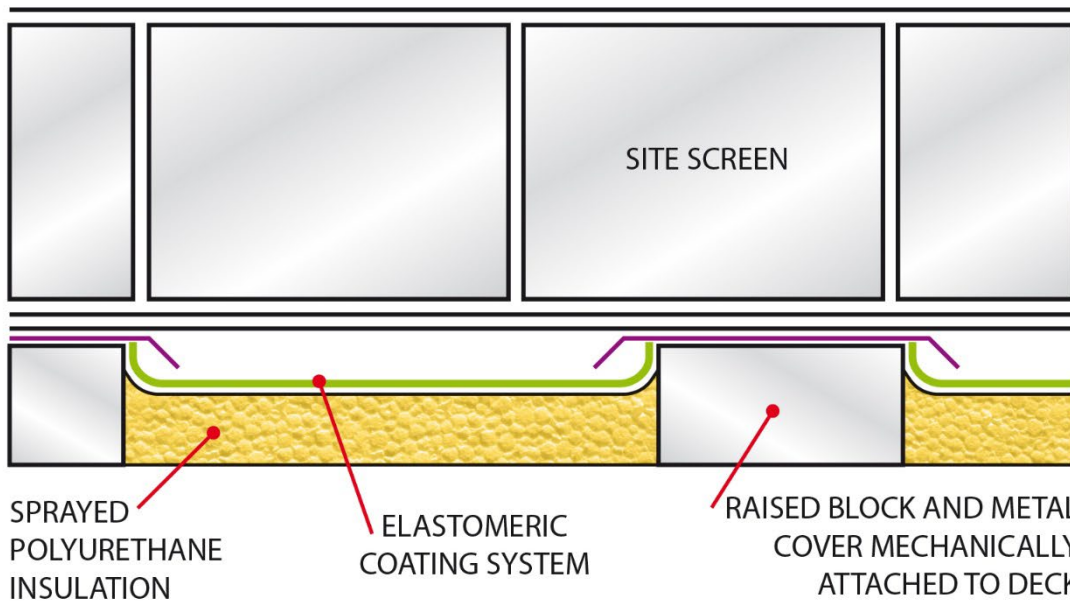
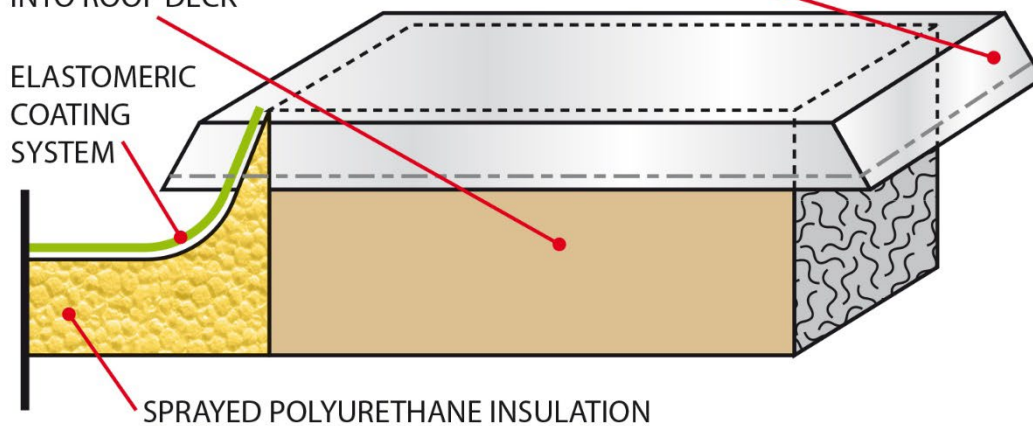

DETAIL 10, SKYLIGHT

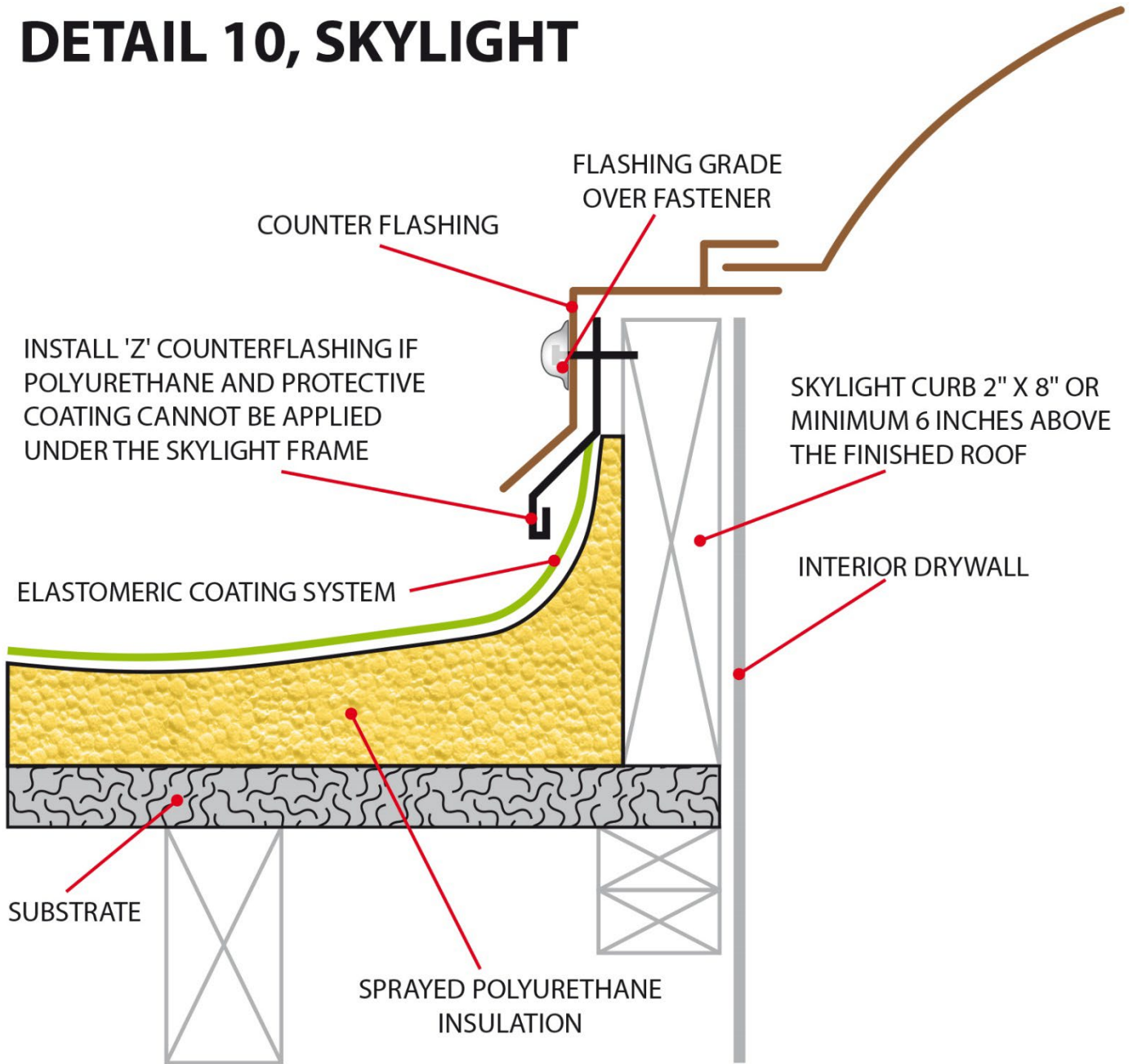

DETAIL 16, STANDARD PERIMETER EDGE METAL FLASHING

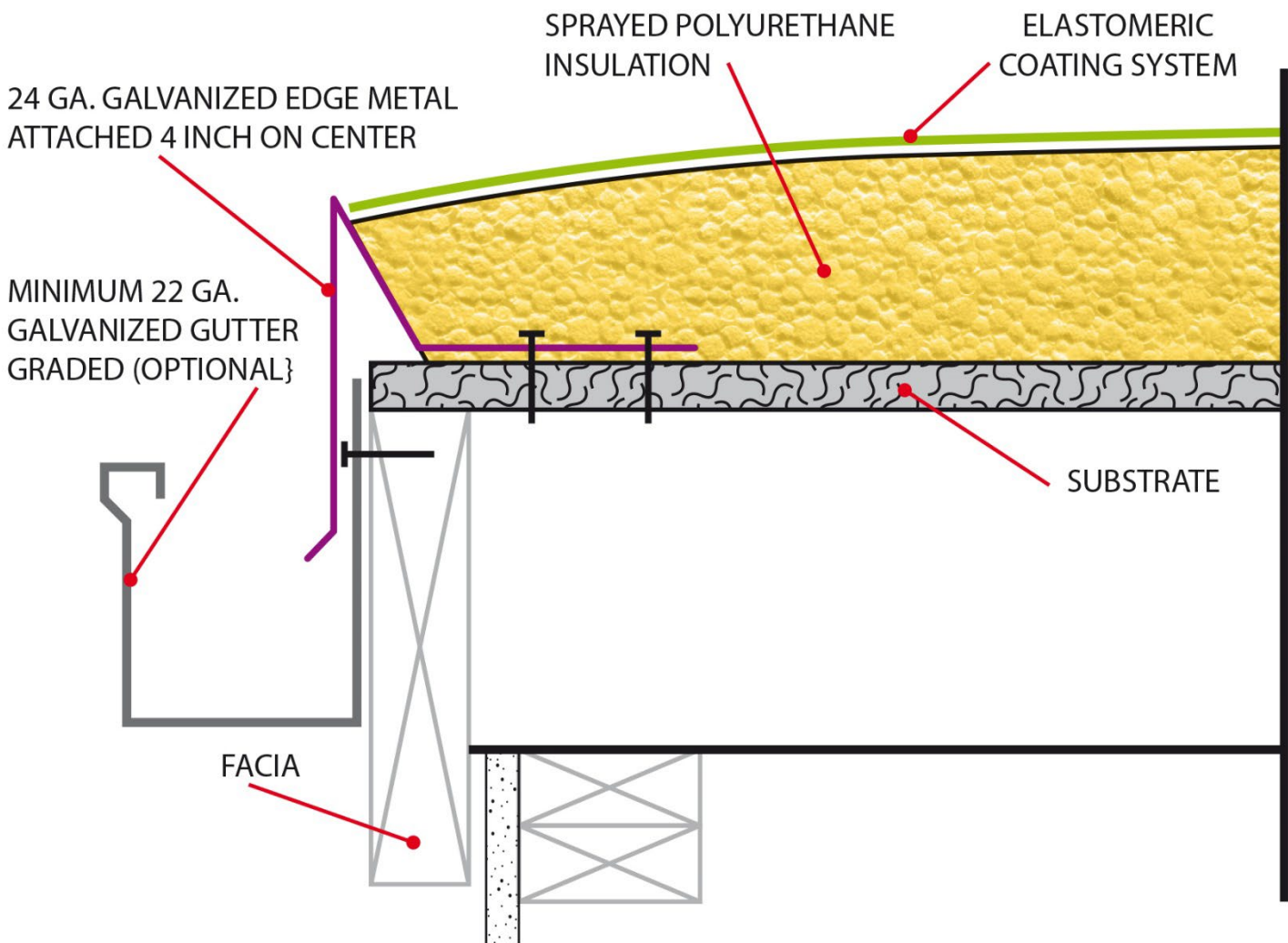

DETAIL 15, STANDING SEAM DECK

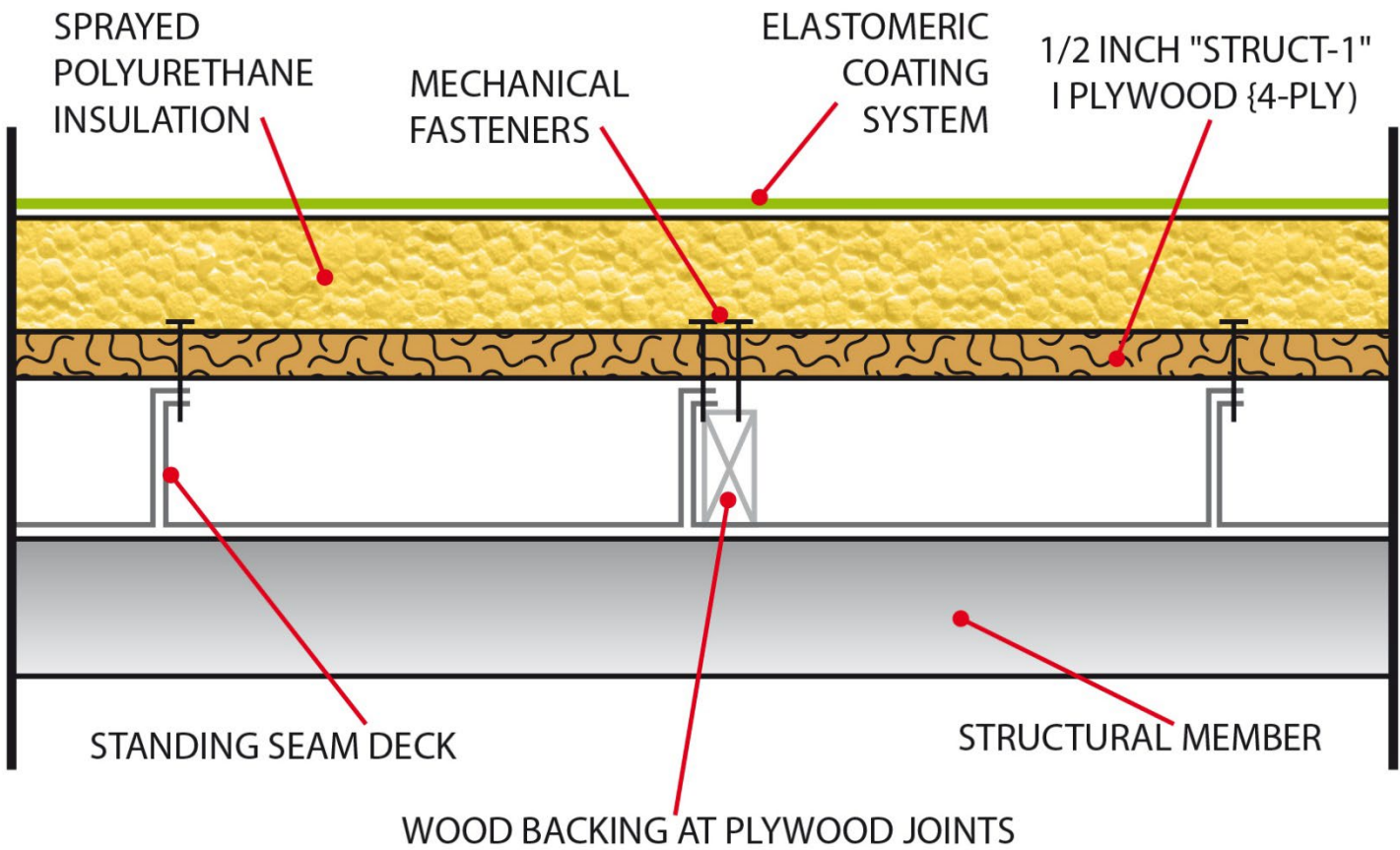

DETAIL 38, SUPPORT BLOCKS / WITH SHEET METAL COVERS

24 GA. GALVANIZED SHEET METAL COVER OVERSIZED ALL SIDES MIN. 1" WITH 1 1/2" TURNDOWN. HENRY RUFTAC OR SINGLE PLY INSTALLED OVER BLOCK. MECHANICAL FASTENERS THROUGH SHEET METAL MUST BE CAULKED.

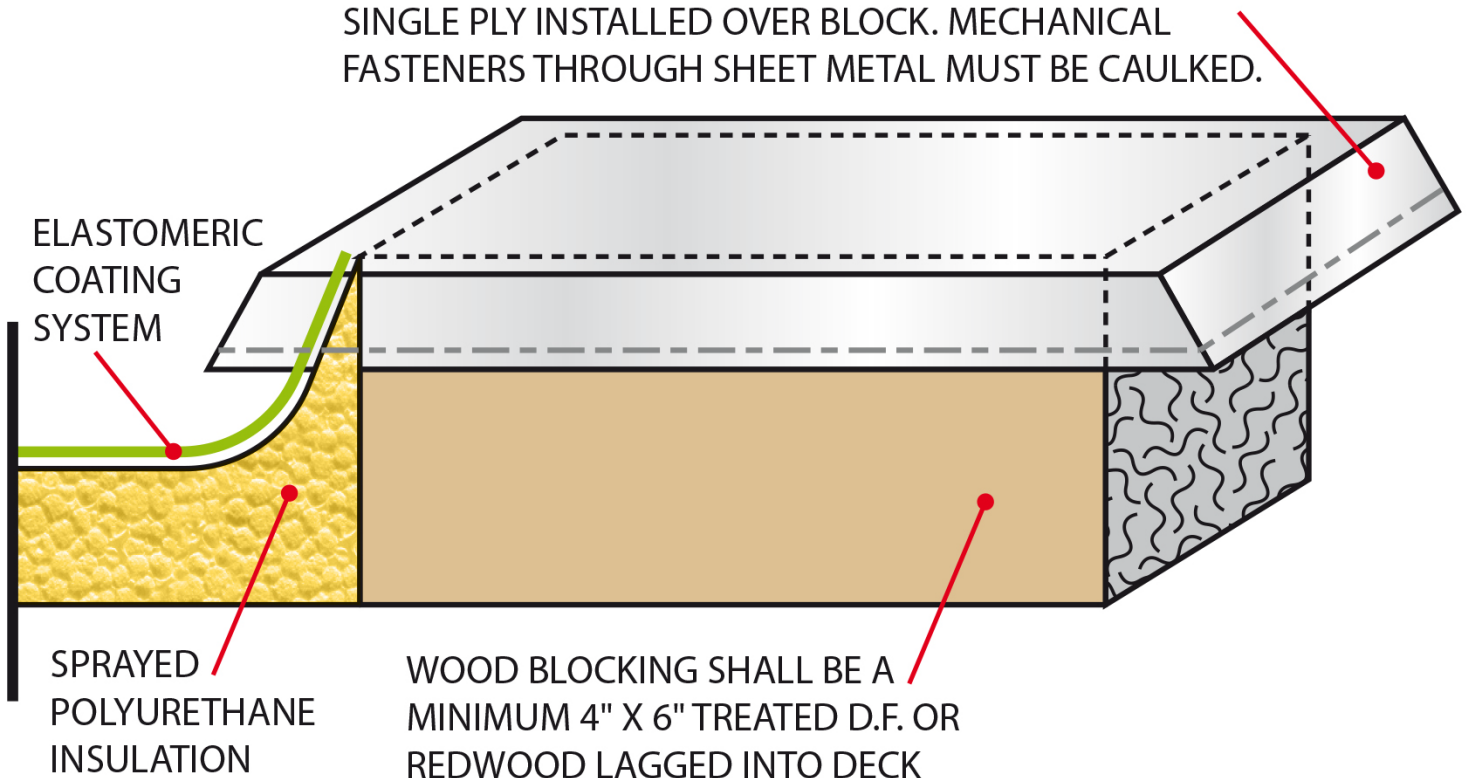

DETAIL 7, THRU-WALL SCUPPER

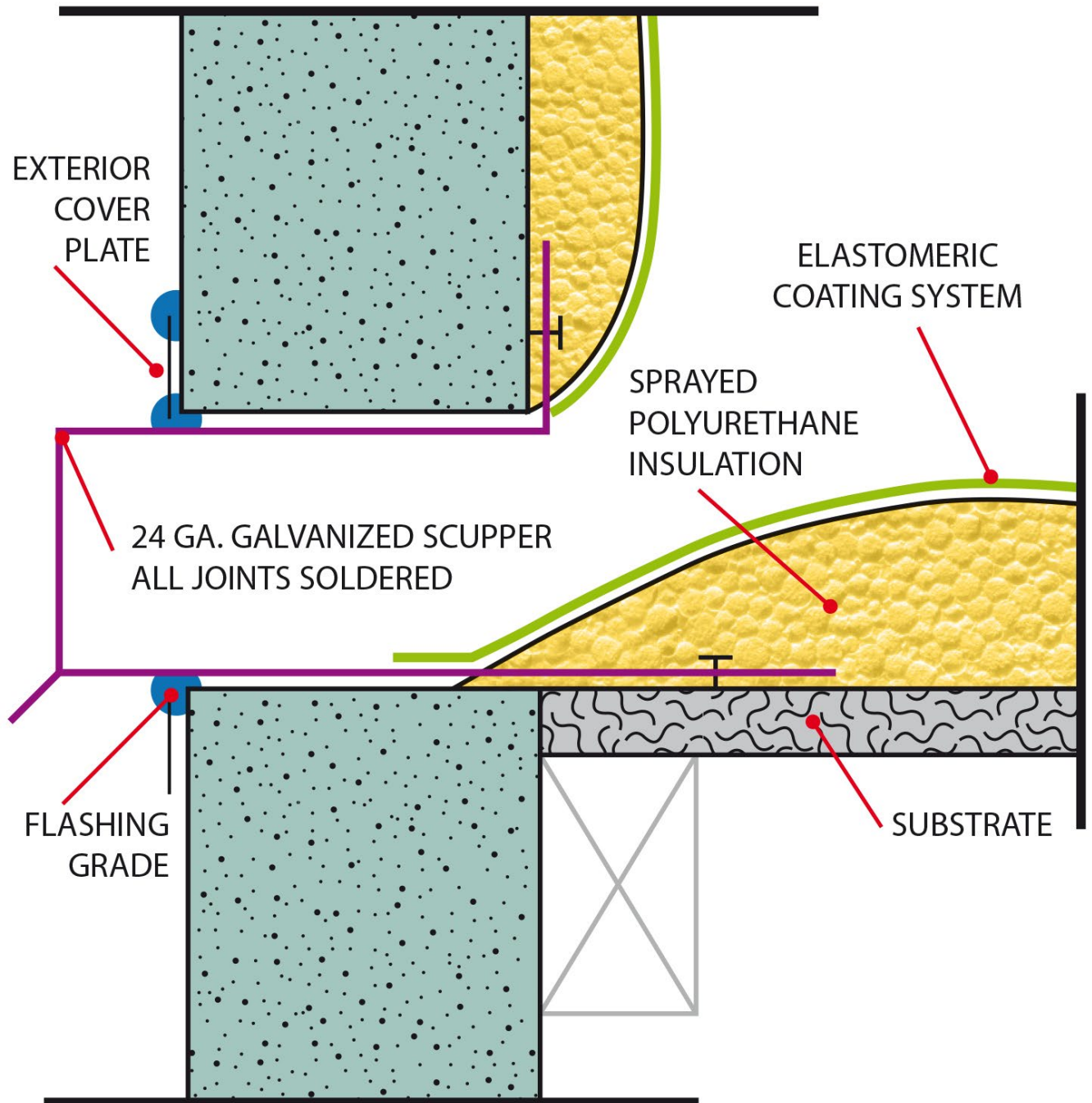

DETAIL 14, WATER BLOCK

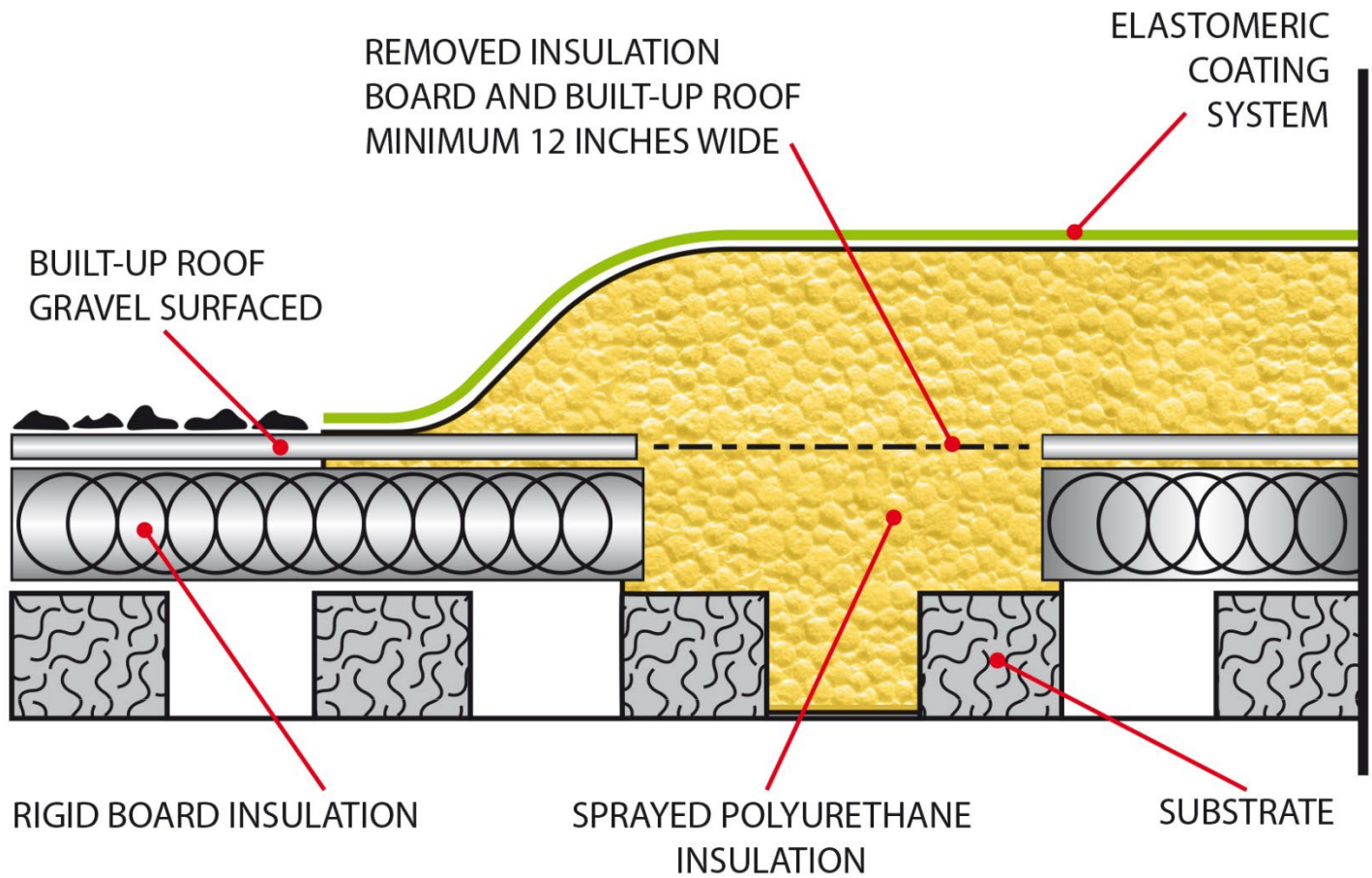

DETAIL 36, WINDOW SILL AT ROOF

